



Pyxis[®]

PRODUCT CATALOG

**PRECISION WATER
MONITORING SOLUTIONS.**

© 2026 Pyxis Lab, Inc.

**THIS PAGE IS INTENTIONALLY
LEFT BLANK**

**THIS PAGE IS INTENTIONALLY
LEFT BLANK**



Water Professionals Deserve Better Tools™

Revolutionizing Water & Fluid Monitoring through Smart Sensor Technology

Pyxis Lab, Inc. is at the forefront of innovation in water and fluid chemistry monitoring, delivering advanced sensing technologies and intelligent solutions that provide real-time visibility into the systems that matter most.

Our comprehensive portfolio includes inline and handheld devices, panel-mounted analyzers, and cloud-connected platforms—engineered to deliver accurate, continuous insight across all key performance parameters critical to system health, efficiency, and compliance.

Beyond technology, Pyxis is driven by a rapid, application-focused R&D team composed of experienced water treatment professionals. This unique foundation enables us to quickly develop and refine solutions that address real-world challenges across municipal, industrial, and specialized fluid systems.

With flexible connectivity and seamless integration into existing infrastructure, our platforms support modern, data-driven operations while remaining practical, intuitive, and reliable in the field.

By combining deep application expertise with cutting-edge engineering, Pyxis Lab empowers operators to optimize processes, reduce chemical usage, and protect system performance with greater confidence and control.

Table of Contents

Product Category	Page Number
Handheld Devices	6
Inline Sensors	26
Liquid Level Sensors	62
Panelized Analyzer Solutions	72
Adapters & Accessories	94
Calibration Standards & Reagents	104
Software Solutions	112



HANDHELD DEVICES



Pyxis Lab's handheld devices deliver fast, reliable water analysis in a portable, field-ready format, with select models offering multi-parameter capabilities for added versatility. Certain instruments also feature proprietary direct-read methods, enabling accurate measurements without complex sample preparation—helping operators make confident, real-time decisions in the field.



SP-350 Direct-Pour Sample Cell PTSA Handheld Meter.

The SP-350 is a simple-to-use handheld fluorometer specifically designed for the direct concentration measurement of PTSA (0–300ppb). Designed for industrial cooling, boiler and process water, this unique handheld allows water samples to be directly filled into the sample cell.

0–300ppb



KEY FEATURES

- › Color & Turbidity Compensation to Eliminate Measurement Interferences
- › Turbidity Over-Range Alarm features for Samples with Excessive Turbidity
- › No Sample Cuvette Required
- › Large-Color Graphic Screen with LOCK-IN feature when Reading has Stabilized
- › Waterproof and Drop Resistant Design
- › Integrated Sample Cell Cleanliness Diagnostics Function for Cleaning Frequency
- › Bluetooth® Enabled for Wireless Customization/Configuration
- › Customizable Display Output Value as ppm Product vs. ppb Tracer via uPyxis®



Item	Specification
Part Number	50206
Range	0–300ppb PTSA
Battery	9V Alkaline Battery
Display	TFT-LCD, Visible under direct sunlight
Sample Temperature Range	40–106 °F (4–41 °C)
Measurement Cycle	15–999min (Adjustable via uPyxis App)
Humidity	85% at 106 °F (41°C)
Environmental	IP-67
Regulation	CE, RoHS
Communication	Bluetooth® 5.0

SP-380 Dual Parameter Handheld PTSA + Fluorescein Meter.

The SP-380 is a simple to use handheld fluorometer specifically designed for the direct concentration measurement of PTSA (0–300ppb) and Fluorescein (0–600ppb). It's applications are industrial cooling, boiler and process water. The sensor allows water samples to be directly filled into the sample cell.

0–300ppb PTSA

0–600ppb Fluorescein



KEY FEATURES

- › Color & Turbidity Compensation to Eliminate Measurement Interferences
- › Turbidity Over-Range Alarm features for Samples with Excessive Turbidity
- › No Sample Cuvette Required
- › Large-Color Graphic Screen with LOCK-IN feature when Reading has Stabilized
- › Waterproof and Drop Resistant Design
- › Integrated Sample Cell Cleanliness Diagnostics Function for Cleaning Frequency
- › Bluetooth® Enabled for Wireless Customization/Configuration
- › Customizable Display Output Value as ppm Product vs. ppb Tracer via uPyxis®



Item	Specification
Part Number	50208
PTSA Range	0–300ppb PTSA
Fluorescein Range	0–600ppb Fluorescein
Battery	9V Alkaline Battery
Display	TFT-LCD, Visible under direct sunlight
Sample Temperature Range	40–106 °F (4–41 °C)
Measurement Cycle	15–999min (Adjustable via uPyxis App)
Humidity	85% at 106 °F (41°C)
Environmental	IP-67
Regulation	CE, RoHS
Communication	Bluetooth® 5.0



SP-350P

Single Parameter Meter for Fluorescent Polymer.

The SP-350P is a simple to use handheld fluorometer that offers direct measurement of Fluorescent (Tagged) Polymer. Fluorescent Polymer is a tracer chemical commonly used in cooling and process water applications.

0-20ppm



KEY FEATURES

- › Color & Turbidity Compensation to Eliminate Measurement Interferences
- › No Sample Cuvette Required
- › No Sample Lid Design eliminates Shielding from Ambient Light
- › Large-Color Graphic Screen with LOCK-IN feature when Reading has Stabilized
- › Waterproof and Drop Resistant Design
- › Integrated Sample Cell Cleanliness Diagnostics Function for Cleaning Frequency
- › Bluetooth® Enabled for Wireless Customization/Configuration
- › Easy-to-Clean Sample Cell with Pyxis Lab, Inc. Handheld Cleaning Kit



Item	Specification
Part Number	50228
Range	0.1-20.0ppm; ±0.1ppm
Excitation Wavelength	410nm LED; ±1nm
Emission Wavelength	470nm; ±1nm
Sample Temperature Range	40-106 °F (4-41 °C)
Measurement Cycle	15-999min (Adjustable via uPyxis App)
Humidity	85% at 106 °F (41°C)
Environmental	IP-67
Regulation	CE, RoHS
Communication	Bluetooth® 5.0
Calibration Solution Point	0 / 10 / 20ppm

SP-380P

Dual Parameter Handheld PTSA + Fluorescent Polymer.

The SP-380P is a simple to use handheld fluorometer that offers direct measurement of PTSA and Fluorescent (Tagged) Polymer. Fluorescent Polymer and PTSA are tracer chemicals commonly used in cooling and process water applications.

0-300ppb PTSA

0-600ppb Fluorescein



KEY FEATURES

- › Color & Turbidity Compensation to Eliminate Measurement Interferences
- › Turbidity Over-Range Alarm features for Samples with Excessive Turbidity
- › No Sample Cuvette Required
- › Large-Color Graphic Screen with LOCK-IN feature when Reading has Stabilized
- › Waterproof and Drop Resistant Design
- › Integrated Sample Cell Cleanliness Diagnostics Function for Cleaning Frequency
- › Bluetooth® Enabled for Wireless Customization/Configuration
- › Customizable Display Output Value as ppm Product vs. ppb Tracer via uPyxis®



Item	Specification
Part Number	50402
PTSA Range	0-300ppb PTSA
Fluorescent Polymer Range	0.1-20.0ppm; ±0.1ppm
Battery	9V Alkaline Battery
Display	TFT-LCD, Visible under direct sunlight
Sample Temperature Range	40-106 °F (4-41 °C)
Measurement Cycle	15-999min (Adjustable via uPyxis App)
Humidity	85% at 106 °F (41°C)
Environmental	IP-67
Regulation	CE, RoHS
Communication	Bluetooth® 5.0



SP-395T Handheld Meter for Tolytriazole Measurement.

The SP-395T handheld fluorometer is a patented Pyxis Lab® device not offered anywhere else in the world. This device utilizes UV light absorbance to detect TolyTriazole (TTA) content in water.

0-10ppm TTA



KEY FEATURES

- › Sample Acidification is NOT REQUIRED
- › Automatically Compensates for Color and Turbidity
- › No Sample Cuvette Needed!
- › Large Color Graphic Screen visible under Direct Sunlight



Item	Specification
Part Number	50209
Range	0-10ppm Tolytriazole; ±0.2ppm
Battery	9V Alkaline Battery
Display	TFT-LCD, Visible under direct sunlight
Sample Temperature Range	40-106 °F (4-41 °C)
Measurement Cycle	15-999min (Adjustable via uPyxis App)
Humidity	85% at 106 °F (41°C)
Environmental	IP-67
Regulation	CE, RoHS
Communication	Bluetooth® 5.0

SP-400 Dual Parameter Handheld PTSA + Conductivity Meter.

The SP-400 is a simple to use handheld fluorometer specifically designed for the direct concentration measurement of PTSA (0-300ppb) and Conductivity (0-15,000µS/cm). Designed for industrial cooling and boiler and process water. This unique handheld allows water samples to be directly filled into the sample cell.

0-300ppb PTSA

0-15,000µS/cm Conductivity



KEY FEATURES

- › Color & Turbidity Compensation to Eliminate Measurement Interferences
- › Turbidity Over-Range Alarm features for Samples with Excessive Turbidity
- › No Sample Cuvette Required
- › Large-Color Graphic Screen with LOCK-IN feature when Reading has Stabilized
- › Waterproof and Drop Resistant Design
- › Integrated Sample Cell Cleanliness Diagnostics Function for Cleaning Frequency
- › Bluetooth® Enabled for Wireless Customization/Configuration
- › Customizable Display Output Value as ppm Product vs. ppb Tracer via uPyxis®



Item	Specification
Part Number	50221
PTSA Range	0-300ppb PTSA
Conductivity Range	1-15,000µS/cm with ATC ±1% or ±1µS/cm Precision
Battery	9V Alkaline Battery
Display	TFT-LCD, Visible under direct sunlight
Sample Temperature Range	40-106 °F (4-41 °C)
Measurement Cycle	15-999min (Adjustable via uPyxis App)
Humidity	85% at 106 °F (41°C)
Environmental	IP-67
Regulation	CE, RoHS
Communication	Bluetooth® 5.0



SP-505 Six Key Parameters, One Robust Handheld.

The SP-505 is a military grade device that can measure up to 5 key water parameters and also offers colorimetric Free & Total DPD Chlorine. The SP-505 is waterproof and drop-resistant.



- 0-100 NTU
- 1-15,000µS/cm
- 0-10ppm F/T Chlorine
- 0-14pH
- ±1,500mV

KEY FEATURES

- › Breakthrough Multiparameter Colorimeter/Turbidimeter Technology in One Rugged Design
- › pH / ORP / Conductivity / Turbidity (ISO-7027) / Temperature / Free & Total DPD Chlorine
- › Uses Traditional DPD Free & Total Powder Pillow Reagents (Pyxis or Others)
- › Waterproof Bluetooth® Enabled 3.7V Battery Powered pH/ORP Module
- › Requires NO Disassembly in the Field for pH/ORP Module Replacement
- › Intelligent Sensor Aging & Humidity Detection Capability
- › Integrated Sample Cell Cleanliness Diagnostics
- › 8G Historical Data with Calendar Time Mark
- › Color Screen with Parameter LOCK-IN Function after Sample Stabilization



Item	Specification
Part Number	50355
Turbidity	0-100NTU; ±0.1NTU
Conductivity	1-15,000µS/cm with ATC ±1% or ±1µS/cm Precision
pH	0-14 with ATC; ±0.01pH Precision
ORP	±1,500mV; ±1mV Precision
Free/Total Chlorine	0.00-10.00ppm (DPD Methodology)
Operational Temperature	0-40 °C (32-104 °F)
Environmental	IP-67
Regulation	CE, RoHS
Communication	Bluetooth® 5.0
Display	Color LCD, visible under direct sunlight

SP-600 Water Multimeter & Colorimeter in ONE.

The SP-600 handheld multimeter is an easy to use tool for the Industrial and Municipal water market. Quickly measure the Conductivity, TDS, Resistivity, pH, ORP, Temperature and DPD Free/Total Chlorine.



- 10-30MΩ
- 1-200,000µS/cm
- 0-14pH
- ±1,500mV
- 0-10ppm F/T Chlorine

KEY FEATURES

- › Breakthrough Multiparameter Colorimeter/Turbidimeter Technology in One Rugged Design
- › pH / ORP / Conductivity / TDS / Resistivity / Temperature / Free & Total DPD Chlorine
- › Uses Traditional DPD Free & Total Powder Pillow Reagents (Pyxis or Others)
- › Waterproof Bluetooth® Enabled 3.7V Battery Powered pH/ORP Module
- › Requires NO Disassembly in the Field for pH/ORP Module Replacement
- › Intelligent Sensor Aging & Humidity Detection Capability
- › Integrated Sample Cell Cleanliness Diagnostics
- › 8G Historical Data with Calendar Time Mark
- › Color Screen with Parameter LOCK-IN Function after Sample Stabilization



Item	Specification
Part Number	50353
Resistivity	10-30MΩ; ±1%
Conductivity	1-200,000µS/cm with ATC ±1% or ±0.2µS/cm Precision
pH	0.00-14.00 with ATC; ±0.01pH Unit Precision
ORP	±1,500mV; ±1mV Precision
Free / Total Chlorine	0.00-10.00ppm; ±0.01ppm (DPD Methodology)
Operational Temperature	0-40 °C (32-104 °F)
Display	Color LCD, visible under direct sunlight
Environmental	IP-67
Regulation	CE, RoHS
Communication	Bluetooth® 5.0



SP-710

Key Water Treatment Parameters, Simultaneously.

The SP-710 multimeter is capable of measuring up to 6 key water treatment parameters simultaneously including pH, Conductivity, PTSA, Temperature, ORP and TMB Free/Total Chlorine, making it perfect for cooling tower applications.

- 0-300ppb
- 1-15,000µS/cm
- 0-2.2ppm F/T Chlorine
- 0-14pH
- ±1,500mV



KEY FEATURES

- › Breakthrough Multiparameter Functionality in One Rugged Design
- › pH / ORP / Conductivity / PTSA / Temperature / Free & Total TMB Chlorine
- › Uses Pyxis Lab, Inc. TMB Free & Total Chlorine Reagent Dropper Kits
- › Waterproof Bluetooth® Enabled 3.7V Battery Powered pH/ORP Module
- › Requires NO Disassembly in the Field for pH/ORP Module Replacement
- › Intelligent Sensor Aging & Humidity Detection Capability
- › Integrated Sample Cell Cleanliness Diagnostics
- › 8G Historical Data with Calendar Time Mark
- › Color Screen with Parameter LOCK-IN Function after Sample Stabilization



Item	Specification
Part Number	50352
PTSA	0-300ppb; ±1ppb or 1% Precision
Conductivity	1-15,000µS/cm with ATC ±1% or ±1µS/cm Precision
pH	0-14 with ATC; ±0.01pH Precision
ORP	±1,500mV; ±1mV Precision
Free/Total Chlorine TMB	0-2.2ppm (TMB Methodology)
Operational Temperature	0-40 °C (32-104 °F)
Environmental	IP-67
Regulation	CE, RoHS
Communication	Bluetooth® 5.0
Display	Color LCD, visible under direct sunlight

SP-710B

The Perfect Boiler Water Handheld Multimeter.

The SP-710B can measure for pH, Conductivity, PTSA, Temperature, ORP and Fluorescein, making it perfect for boiler water applications.

- 0-300ppb
- 1-15,000µS/cm
- 0-600ppb Fluorescein
- 0-14pH
- ±1,500mV



KEY FEATURES

- › Breakthrough Multiparameter Functionality in One Rugged Design
- › pH / ORP / Conductivity / PTSA / Temperature / Fluorescein
- › Uses Pyxis Lab, Inc. TMB Free & Total Chlorine Reagent Dropper Kits
- › Waterproof Bluetooth® Enabled 3.7V Battery Powered pH/ORP Module
- › Requires NO Disassembly in the Field for pH/ORP Module Replacement
- › Intelligent Sensor Aging & Humidity Detection Capability
- › Integrated Sample Cell Cleanliness Diagnostics
- › 8G Historical Data with Calendar Time Mark
- › Color Screen with Parameter LOCK-IN Function after Sample Stabilization



Item	Specification
Part Number	50316
PTSA	0-300ppb; ±1ppb or 1% Precision
Conductivity	1-15,000µS/cm with ATC ±1% or ±1µS/cm Precision
pH	0-14 with ATC; ±0.01pH Precision
ORP	±1,500mV; ±1mV Precision
Fluorescein	0-600ppb; ±0.1ppb or 1%
Operational Temperature	0-40 °C (32-104 °F)
Environmental	IP-67
Regulation	CE, RoHS
Communication	Bluetooth® 5.0
Display	Color LCD, visible under direct sunlight



SP-800

Portable Multiparameter Colorimeter + Turbidimeter.

The SP-800 is a multi-parameter and multi-wavelength colorimeter and turbidimeter specifically designed for Municipal, Environmental and Industrial water analysis.



KEY FEATURES

- › True Turbidity Measurement with White Light & InfraRed LED
- › 7 LED Wavelengths and over 75 Built-In Reagent Based Methods
- › Add User Defined Methods via uPyxis®
- › Bluetooth® Enabled for Wireless Data Transfer & Firmware Updates via uPyxis®
- › Displays a Concentration-Time Profile Curve during Color Development

COLORIMETRIC + UNIQUE PYXIS METHODS

Pyxis Lab, Inc. or other industry-known solid/liquid reagents are directly compatible for use with the SP-800. Pyxis Lab® has developed and provided numerous unique colorimetric and direct-read test methods integrated into the SP-800 that are not available with other market colorimeters. Including:

- › Direct-Read Bleach Concentration
- › Direct-Read Nitrite Concentration
- › Calcium
- › Alkalinity
- › Sulfite
- › Non-Hazardous Zinc



Item	Specification
Part Number	50610
Colorimetric Wavelength	365 / 420 / 455 / 525 / 560 / 570 / 630 nm
Turbidity Excitation Wavelength	White and InfraRed LED
Wavelength Accuracy	±1nm
Absorbance Reproducibility	0.005au (0-1.5au) (3Sigma)
Absorbance Linearity Range	0-1.0au
Turbidity Range	0-200NTU; 1NTU Detection Limit
Environmental	IP-67
Regulation	CE, RoHS
Operational Temperature	40-106 °F (4-41 °C)
Display	Graphical LCD 160x240px, visible under direct sunlight
Humidity	85% at 106 °F (41 °C)

SP-910

Colorimeter, Turbidimeter and Fluorometer in ONE.

The SP-910 is a multi-parameter and multi-wavelength fluorometer, colorimeter and turbidimeter specifically designed for Municipal, Environmental and Industrial water analysis.



KEY FEATURES

- › Direct-Read Fluorescein & PTSA
- › Internal Compensation Algorithm for Sample Color & Turbidity Interference
- › True Turbidity Measurement with White Light & InfraRed LED
- › 7 LED Wavelengths and over 75 Built-In Reagent Based Methods
- › Add User Defined Methods via uPyxis®
- › Bluetooth® Enabled for Wireless Data Transfer & Firmware Updates via uPyxis®
- › Displays a Concentration-Time Profile Curve during Color Development

COLORIMETRIC + UNIQUE PYXIS METHODS

Pyxis Lab, Inc. or other industry-known solid/liquid reagents are directly compatible for use with the SP-800. Pyxis Lab® has developed and provided numerous unique colorimetric and direct-read test methods integrated into the SP-800 that are not available with other market colorimeters. Including:

- › Direct-Read Bleach Concentration
- › Direct-Read Nitrite Concentration
- › Calcium
- › Alkalinity
- › Sulfite
- › Non-Hazardous Zinc



Item	Specification
Part Number	50603
PTSA Range	0-300ppb
Fluorescein Range	0-600ppb
Colorimetric Wavelength	365 / 420 / 455 / 525 / 560 / 570 / 630 nm
Turbidity Excitation Wavelength	White and InfraRed LED
Wavelength Accuracy	±1nm
Absorbance Reproducibility	0.005au (0-1.5au) (3Sigma)
Absorbance Linearity Range	0-1.0au
Turbidity Range	0-200NTU; 1NTU Detection Limit
Environmental	IP-67
Regulation	CE, RoHS
Operational Temperature	40-106 °F (4-41 °C)
Display	Graphical LCD 160x240px, visible under direct sunlight
Humidity	85% at 106 °F (41 °C)



HM-900 Portable Oil-In-Water Handheld Analyzer.

The HM-900 is a handheld portable fluorometer that measures the concentration of multiple oils in water.

- Marine-Offshore Oil
- #1 Diesel/Kerosene
- Heavy Fuel Oil



TWO EXTRACTION METHODS

The HM-900 measures oil content using either traditional hexane extraction or a Pyxis Lab®-prepared non-toxic, non-flammable solvent. This provides a safer, more convenient alternative that reduces sample preparation time. The HM-900 supports both 24 mm and 16 mm sample vials.

SECONDARY STANDARDS

Preparing true oil-in-water calibration standards is time-consuming and prone to error. The HM-900 supports calibration using Pyxis synthetic oil-in-water (OIW) secondary standards, enabling faster calibration, improved repeatability, and extended calibration standard shelf life.

PRE-PROGRAMMED CALIBRATION CURVES

The HM-900 includes three built-in calibration curves for Marine/Offshore Oil, #1 Diesel/Kerosene, and Heavy Fuel Oil. Users can select the desired calibration format for measurement display. In addition, up to seven user-defined calibration curves can be created to support specific oil types.

DIRECT-READ MEASUREMENT

Using UV fluorescence methodology, the HM-900 can directly measure oil-in-water concentrations without extraction. This direct-read method is ideal for samples containing dissolved or lightly emulsified oil.



Item	Specification
Part Number	52201
Wavelength	365/470 (ex/em) and 470/650 (ex/em)
Detection Limit	0.1ppm (Marine-Offshore Oil)
Range	0.1-1,000ppm, Auto-Channel Switch
Display	192x128 LCD, visible under direct sunlight
Enclosure Rating	IP-65
Regulation	CE / RoHS

EM-400 Defend Your System From Algae Growth.

The EM-400 measures in-vivo chlorophyll-a concentration in live algae cells, providing instant, reagent-less monitoring to defend your cooling water or surface water applications.

0.3-100ppb



DESCRIPTION

The EM-400 is an algae handheld monitoring product that measures the in-vivo chlorophyll-a concentration in live algae cells. In-vivo chlorophyll-a is the main photosynthetic pigments of algae and can be used to assess algal biomass. This handheld fluorometer provides instant, reagent-less monitoring capability to understand algae growth dynamic in your system. The EM-400 was designed to be used for alarming or guiding your algicide dosage. Protect your system from being consumed by algae growth!

KEY FEATURES

- Pre-Calibrated with Live Algae Sample & Water Sample with known Chlorophyll-A Concentration
- Automatic Compensation for Color & Turbidity
- No Cuvette Needed
- Sample LOCK-IN Capability
- Bluetooth® 5.0 for Wireless Configuration and Data Sharing via uPyxis®



Item	Specification
Part Number	50508
Range	0.3-50ppb (In-Vivo Chlorophyll-A)
Excitation Wavelength	470nm LED
Emission Wavelength	670nm
Detection Limit	0.1ppb; 1% or 0.1ppb Accuracy
Calibration Setpoint	0 / 10 / 20 / 50ppb Synthetic Chlorophyll-A Standard Solutions available through Pyxis Lab, Inc.
Temperature Range	40-106 °F (4-41 °C)
Display	TFT-LCD, visible under direct sunlight
Environmental	IP-67
Regulation	CE, RoHS
Communication	Bluetooth® 5.0



SP-208 OXIGO

Measure for High & Low Chlorine On the Go!

The SP-208 OXIGO™ Chlorine is a unique pocket colorimeter that measures for Free & Total Chlorine with the capability to add a pH/ORP module at a later time.

0.02–2.2ppm Low Range ClO₂

0.1–10ppm High Range ClO₂



KEY FEATURES

- › DPD Colorimetric Testing of Free & Total Chlorine
- › Color Display with Live Graphical Trend Chart as Color Develops
- › Simple to Use Interface that allows addition of pH/ORP Module
- › Utilizes Pyxis and Other Powder Pillow Reagents (10mL Sample Vial)
- › Seamlessly Integrate our Wireless pH/ORP Module at Any Time!



Item	Specification
Part Number	63068
Low Chlorine Range	0.02–2.2ppm (Free or Total)
High Chlorine Range	0.1–10ppm (Free or Total)
Temperature Range	40–106 °F (4–41 °C)
Cuvette/Sample Vial	10mL / 24mm D Cuvette (MA-24)
Display	340x220 TFT-LCD; visible under direct sunlight
Humidity	85% at 106 °F (41°C)
Environmental	IP-67
Regulation	CE, RoHS
Communication	Bluetooth® 5.0



SP-200 OXIPOCKET

The All-In-One Pocket Colorimeter.

The SP-200 OXIPOCKET is a unique all-in-one pocket colorimeter. Specifically designed for measurement of all primary oxidizing biocides. Also included is the ability to measure disinfectants commonly used in the municipal, domestic and industrial markets.

All Common Oxidizing Biocides & Disinfectants

Total Bromine, Free Chlorine, Total Chlorine, Chlorine Dioxide, Monochloramine, Bleach Concentration, Hydrogen Peroxide, Ozone, Peroxyacetic Acid, Ammonia Nitrogen, etc.



KEY FEATURES

- › Colorimetric Testing of all Conventional Oxidizing Biocides + Disinfectants
- › Unique Pyxis Lab® Peroxyacetic Acid (PAA) Colorimetric Test Method
- › Chlorine Dioxide (ClO₂) Direct-Read Test Method (Mass/Mass)
- › Bleach Concentration Direct-Read Test Method (Mass/Mass)
- › Fully integrated Test Timers with Live Graphical Trend Chart as Color Develops
- › Uses Both Pyxis Lab® and Other Powder Pillow Reagents
- › Meets EPA-334.0 DPD Testing Guidelines for Drinking Water
- › DPD Secondary Verification Liquid Standards Available for EPA Regulated Applications
- › Data Logging - 30,000 Group Storage



Item	Specification
Part Number	50802
PTSA Range	0–300ppb PTSA
Fluorescein Range	0–600ppb Fluorescein
Battery	9V Alkaline Battery
Display	TFT-LCD, Visible under direct sunlight
Sample Temperature Range	40–106 °F (4–41 °C)
Measurement Cycle	15–999min (Adjustable via uPyxis App)
Humidity	85% at 106 °F (41°C)
Environmental	IP-67
Regulation	CE, RoHS
Communication	Bluetooth® 5.0



SP-210 Direct-Read Measurement of Bleach Concentration.

The SP-210 is a pocket analyzer specifically designed to measure real-time mass/mass bleach concentration with a direct-pour sample method.

0.01–16% Mass/Mass Bleach



KEY FEATURES

- › Simple Pour-In Sample Design - Not Affected by Ambient Light, No Sample Vials Needed!
- › Sample Cell Compatible with Concentrated Liquid Bleach Solutions
- › Integrated Cleanliness Diagnostics
- › %Cl₂ Concentration Displayed as Mass/Mass with Auto-Resolution
- › Sample Temperature Displayed as °F and °C
- › Internal RTU Temperature Compensation of Bleach Concentration



Item	Specification
Part Number	50801
Measurement Range	0.01–16% Mass/Mass
Accuracy	±2% of the reading value; ±0.1% of unit range
Method	UV Absorbance - LED
Measurement Wavelength	365 / 395nm; ±1nm
Absorbance Reproducibility	±0.005Abs (0–1.0Abs)
Absorbance Linearity Range	0–2.0Abs
Environmental	IP-67
Regulation	CE, RoHS
Communication	Bluetooth® 5.0

EZ-SERIES pH, ORP, Conductivity Just Got EZ-er.

Our EZ-Series of handhelds measure for pH, ORP or Conductivity in handheld, benchtop and pen formats.

0–14pH

±1,999mV ORP

0–2,000µS/cm Conductivity



KEY FEATURES

- › Live Digital Display Screen on each Device
- › EZ-100 and EZ-101 Displays Electrode Slope and Data Stability Mark
- › Multi-Reading features Allow Auto-Reading and Continuous-Read
- › Support Electrode Calibration Function up to 3-Point Calibration
- › Support Automatic Calibration Function, Automatic Identification of (3) pH Buffer Solutions
- › Support Manual Calibration Function, Custom Standard Solution
- › Automatic/Manual Temperature Compensation ensures Accurate Results (EZ-100/101)
- › Support Data Storage, Deletion and Review, 50 Sets Storage of Measurement Settings (EZ-100/101)
- › With Power Failure Protection Function, Support to Factory Settings
- › IP-54 Protection



Unit	Measurement	Range	Description	Part Number
EZ-10	pH + Temperature	0–14 + 0–60 °C	Simple pH Pen with Digital Display	EZ-10
EZ-20	Conductivity + Temp.	0–2,000µS/cm + 0–60 °C	Simple Conductivity Pen with Digital Display	EZ-20
EZ-100	pH + ORP + Temp.	0–14, ±1,999mV, -5–110 °C	Handheld for Sampling & Measuring pH of Aqueous Solution and Measures Electrode Potential (mV) in Labs or in the Field	63277
EZ-101	pH + ORP + Temp.	0–14, ±1,999mV, -5–110 °C	Benchtop Meter for Sampling & Measuring pH of Aqueous Solution and Measures Electrode Potential (mV) in Labs or in the Field	67840



INLINE SENSORS

Pyxis Lab's inline sensor portfolio is designed for seamless integration into virtually any water treatment system, offering true platform-agnostic compatibility offering both standard outputs 4–20mA Analog and RS-485 Modbus Digital. Engineered with proprietary compensation algorithms, these sensors deliver highly accurate, stable measurements by automatically correcting for real-world interferences—ensuring reliable data across a wide range of operating conditions without the need for complex setup or frequent recalibration.





ST-710 SERIES Robustly Built pH + ORP Sensors.

The ST-710 Series pH and ORP sensors are designed to simplify installation, calibration and operation in process, industrial, waste and cooling water applications.

0-14pH

±1,500mV ORP



KEY FEATURES

- › Dual-Embedded Transmitter 4-20mA and RS-485 supporting Modbus
- › Compact Design for Small Footprint, Ideally Suited for Industrial Applications
- › Tolerant to Frozen Conditions during Shipment or Storage
- › Large Junction Capacity leading to Longer Service Life and Less Maintenance
- › Interfaces with Pyxis Lab, Inc. MA-WB or PowerPACK Series for use with uPyxis® App



Item	ST-710	ST-711	ST-712
Part Number	53001	53002	53003
pH Range	0-14	N/A	0-14
ORP Range	N/A	±1,500mV	±1,500mV
Installation	ST-001 3/4 inch FNPT Glue and Thread Inline Tee Assembly (INCLUDED)		
Outputs	Isolated 4-20mA Analog and Isolated RS-485 Modbus Digital for connection to any Controller, PLC or DCS		
Operational Pressure	60psi (4.1Bar)		
Operational Temperature	4-49 °C (40-120 °F)		
Rating	IP-67		
Regulation	CE, RoHS		

ST-720 SERIES High Range, Smart Inline Conductivity.

Simple to use inline sensors that measures for Conductivity. Built for industrial water treatment applications.

0-100,000µS/cm Conductivity

10-300,000µS/cm Conductivity



KEY FEATURES

- › Large Dynamic Ranges (0-100,000µS/cm and 10-300,000µS/cm)
- › (2) 4-20mA and RS-485 Modbus Outputs for Temperature and Conductivity
- › Conductivity Value Compensated based on the measured Temperature to Normal Value = 25 °C
- › Wireless Diagnosis and Calibration via uPyxis® App; Enabled with MA-WB
- › Cell Constant - K Factor = 0.3

ST-720SS STAINLESS STEEL VARIANT

The ST-720SS sensor stainless steel format for high temperature applications. The specifications are identical to the ST-720



Item	ST-720	ST-726
Part Number	53101	53114
Conductivity Range	0-100,000µS/cm; ±10µS/cm or 1.5%	10-300,000µS/cm; ±10µS/cm or 1.5%
Temperature Range	0-100 °C (32-212 °F); ±0.2% of the value	
Cell Constant (K)	0.3	
Outputs	Isolated 4-20mA Analog and Isolated RS-485 Modbus Digital for connection to any Controller, PLC or DCS	
Operational Pressure	0-100psi	
Operational Temperature	0-49 °C (32-120 °F)	
Rating	IP-67	
Regulation	CE, RoHS	



ST-72X SERIES

Ultra-Low, Stainless Steel Conductivity Sensors.

Industrial grade inline ultra-low conductivity sensors specially designed for pure and ultra-pure water applications.

0.02–10.0µS/cm Conductivity

0.02–1,000.0µS/cm Conductivity

0.02–200.0µS/cm Conductivity



KEY FEATURES

- › Easy Installation into ¾ inch FNPT Standard Pipe Tee
- › Latest Short Pulse Type Detection Method Technology
- › Built-In Temperature Sensor for Automatic Compensation
- › Front-End Fully Digital Detection Technology
- › Built-In Transmitter without Pre-Amplifier with Ultra-Low Drift
- › (2) 4-20mA Isolated Analog and RS-485 Modbus Digital Outputs
- › Stainless Steel Housing suitable for Harsh Environments
- › Pollution-Resistant and Anti-Interference Design
- › Ultra-Low Detection 0.02µS/cm (50MΩ Resistivity)



Item	ST-722	ST-724	ST-725	ST-728
Part Number	53103	10009	53108	53117
Conductivity Range	10–10,000µS/cm	0.02–1,000µS/cm	0.02–200µS/cm	0.02–10.00µS/cm
Temperature Range	32–212 °F (0–100 °C)			
Installation	ST-001 ¾ inch FNPT Glue and Thread Inline Tee Assembly (INCLUDED)			
Outputs	Isolated 4-20mA Analog and Isolated RS-485 Modbus Digital for connection to any Controller, PLC or DCS			
Operational Pressure	up to 100psi (0.7MPa)			
Operational Temperature	4–49 °C (40–120 °F)			
Rating	IP-67			
Regulation	CE, RoHS			

ST-723

High Temperature/Pressure Inline Conductivity.

Simple to use inline sensors that measures for Conductivity. Built for industrial water treatment applications.

0–20,000µS/cm Conductivity



KEY FEATURES

- › (2) 4-20mA Isolated Analog and RS-485 Modbus Digital Outputs
- › Wireless Configuration and Calibration via MA-CR Bluetooth® Adapter and uPyxis® App
- › Rugged 316L Stainless Steel and PEEK Design
- › Hastelloy 2-Pole Electrode Sensor Head

TYPICAL APPLICATIONS

- › Boiler Feedwater
- › Pressurized Boiler Surface Sample (Timed Capture)
- › Pre-Cooled Boiler Surface Sample (Constant Flow with ATC)
- › Process Water or High Temperature/Pressure



Item	ST-723
Part Number	53106
Conductivity Range	0–20,000µS/cm
Temperature Range	32–392 °F (0–200 °C)
Conductivity Precision	±10% µS/cm or ±3.5% FS, whichever is greater
Cell Constant (K)	K = 0.3
Operating Temperature	41–392 °F (5–200 °C)
Sample Pressure	Up to 300psi (20.6Bar) at 390 °F
Environmental	IP-67
Regulation	CE, RoHS
Installation	¾ inch NPT



ST-730 SERIES Tolerant to Fouling, Turbidity Sensors.

Robust turbidimeters designed for a wide range of turbidity monitoring in various applications. Tolerant to fouling and more robust to particulate and air bubble challenges.

- 0-10NTU
- 0-1,000NTU
- 0-100NTU
- 0-10,000NTU



KEY FEATURES

- › InfraRed LED Light Source with 90° Scattering
- › Accurate Readings in Complex Flow Systems
- › Compact Design with Small Footprint
- › Integrated 4-20mA + RS-485 Modbus Outputs
- › Bluetooth® Enabled with the MA-WB Bluetooth® Adapter or PowerPACK Auxiliary Boxes
- › Wireless Diagnostics & Calibration via uPyxis® Mobile or Desktop App



Item	ST-730	ST-730B	ST-731	ST-735
Part Number	53201	53202	53505	53204
Turbidity Range	0-100NTU	0-1,000NTU	0-10NTU	0-10,000NTU
Accuracy	±2% of the Reading			
Installation	ST-001 3/4 inch FNPT Glue and Thread Inline Tee Assembly (INCLUDED)			
Outputs	Isolated 4-20mA Analog and Isolated RS-485 Modbus Digital for connection to any Controller, PLC or DCS			
Operational Pressure	up to 100psi (0.7MPa)			
Operational Temperature	4-49 °C (40-120 °F)			
Rating	IP-66			
Regulation	CE, RoHS			

LT-73X SERIES Ultra Low Turbidity Sensors.

Proprietary inline turbidity sensors offered in a variety of ranges with ultra-low resolution.

- 0.001-5.0NTU
- 0.002-40.0NTU
- 0.002-1,000NTU



KEY FEATURES

- › 4-20mA Isolated Analog and RS-485 Modbus Digital Outputs
- › Warm White LED (EPA) and 860nm InfraRed (ISO) Light Sources Available
- › Flat Quartz Glass End for Simple Cleaning and Maintenance
- › Bluetooth® Enabled with MA-CR Adapter for use with uPyxis® App



Item	LT-736	LT-737	LT-739
Part Number	53215	53216	53221
Turbidity Range	0.002-1,000.0NTU	0.002-40.0NTU	0.001-5.0NTU
Light Source & Compliance	Warm White LED, EPA-180.1	Warm White LED, EPA-180.1	Warm White LED, EPA-180.1

Item	LT-736B	LT-737B	LT-739B
Part Number	53223	53225	53224
Turbidity Range	0.002-1,000.0NTU	0.002-40.0NTU	0.001-5.0NTU
Light Source & Compliance	860nm InfraRed, ISO-7027	860nm InfraRed, ISO-7027	860nm InfraRed, ISO-7027

Item	General Specifications
Installation	FR-100 Flow Reservoir Assembly or FT-100 Inline Tee with 1.5" NPT Glue & Thread
Outputs	Isolated 4-20mA Analog and Isolated RS-485 Modbus Digital for connection to any Controller, PLC or DCS
Operational Pressure	100psi (6.9Bar)
Operational Temperature	33.8-131 °F (1-50 °C)
Rating	IP-67
Regulation	CE, RoHS



LT-63X SERIES

Self-Wiping, Stainless Steel Turbidity/TSS Sensors.

Industrial grade inline ultra-low conductivity sensors specially designed for pure and ultra-pure water applications.

0.00–500.00NTU

0.00–1,000.00NTU

0.00–30,000mg/L

0.00–30,000mg/L



KEY FEATURES

- › Ultra-Low Resolution (0.1NTU or 0.1g/L)
- › Built-In Transmitter without Pre-Amplifier or Meter Head
- › 4-20mA and RS-485 Modbus Outputs for Direct Connection to Any Receiving Device
- › Simple Wireless Calibration via uPyxis® App and MA-CR Bluetooth® Adapter
- › Self-Cleaning with Wiper Timer Interface programmable via uPyxis®
- › Optional Calibration with Pyxis Lab, Inc. Formazin Calibration Solutions or Field Water Sample
- › ¾ inch NPT Threaded for Fixed Submersion
- › Inline Installation Assembly Available



Item	LT-631	LT-632	LT-633	LT-635
Part Number	53249	53250	10002	53251
Turbidity Range	0.00–500.00NTU	0.00–1,000.00 NTU	0.00–4,000NTU	N/A
TSS Range	N/A	N/A	N/A	0.00–30g/L
Material	316L Stainless Steel Body and Wiper Arm, PTFE Wiper Blade			
Installation	Submersed Fixed Conduit 3/4in MNPT Threaded Fitting, Hoisting Chain or Inline Installation Housing			
Outputs	Isolated 4-20mA Analog and Isolated RS-485 Modbus Digital for connection to any Controller, PLC or DCS			
Operational Pressure	45psi (3.1Bar)			
Operational Temperature	4–49 °C (40–120 °F)			
Rating	IP-67			
Regulation	CE, RoHS			

HM-500 SERIES

Oil-In-Water Concentration Inline Sensors.

The HM-500 Series fluorometer sensors measure the concentration of Oil In Water, read as ppm Marine Crude-Offshore Oil.

0–10ppm

0–100ppm

0–1,00ppm



KEY FEATURES

- › Provided with ST-001 Inline Tee Assembly ¾ inch FNPT/CPVC
- › HM-500SS Series variants available in 304 Stainless Steel ¾ inch FNPT for Harsh Applications
- › Unique Design with Extra Photo-Electric Components
- › Automatically Compensates for Color & Turbidity Contamination
- › 4-20mA and RS-485 Modbus Outputs for Direct Connection to Any Receiving Device
- › Bluetooth® Enabled when MA-WB or PowerPack Series Adapters
- › Lower Cost and Higher Accuracy vs Conventional UC Fluorometers for Oil-In-Water



Item	HM-500	HM-510	HM-520
Part Number	52101	52102	52106
Oil-In-Water Range	0–10ppm	0–1,000ppm	0–100ppm
LOD	0.1ppm	0.5ppm	0.5ppm
Installation	ST-001 ¾ inch FNPT Glue and Thread Inline Tee Assembly (INCLUDED)		
Outputs	Isolated 4-20mA Analog and Isolated RS-485 Modbus Digital for connection to any Controller, PLC or DCS		
Operational Pressure	up to 100psi (6.9Bar)		
Operational Temperature	4–49 °C (40–120 °F)		
Rating	IP-67		
Regulation	CE, RoHS		



ST-500 SERIES

The Industry's Best PTSA Inline Sensors.

The ST-500 Series are inline PTSA sensors that revolutionized the industry with proprietary internal compensation algorithms for Color & Turbidity. No more wasting chemical due to false low PTSA readings!

- 0-40ppb
- 0-300ppb
- 0-500ppb



KEY FEATURES

- › Internal Compensation for Color & Turbidity for True PTSA Value
- › Includes ST-001 Inline Tee Assembly
- › Bluetooth® Enabled when used with the MA-WB Bluetooth® Adapter
- › Wireless Calibration, Configuration, Diagnostics and Data Export via uPyxis® App
- › ST-500SS Stainless Steel variant available for Harsh Applications
- › Short Fluidic Channel for Simple Cleaning
- › Narrow Wavelength Band Gallium Phosphide Photodiode
- › High Temperature Tolerant and Humidity Resistant Optical Filters



Item	ST-500	ST-500RO	ST-587
Part Number	53103	10009	53108
PTSA Range	0-300ppb (Default)	0-40ppb	0-500ppb
Turbidity Output Range	N/A	N/A	0-200NTU
Installation	ST-001 3/4 inch FNPT Glue and Thread Inline Tee Assembly (INCLUDED)		
Outputs	Isolated 4-20mA Analog and Isolated RS-485 Modbus Digital for connection to any Controller, PLC or DCS		
Operational Pressure	up to 100psi (0.7MPa)		
Operational Temperature	4-49 °C (40-120 °F)		
Rating	IP-67		
Regulation	CE, RoHS		

ST-525 SERIES

Inline Sensors for Fluorescein Monitoring.

A proprietary design that utilizes LED light sources for the direct measurement of Fluorescein. Built for industrial boiler water and process treatment applications.

- 0-60ppb
- 0-500ppb



KEY FEATURES

- › (2) 4-20mA Isolated Analog and RS-485 Modbus Digital Outputs
- › Wireless Configuration and Calibration via MA-WB Bluetooth® Adapter and uPyxis® App
- › ST-525SS and ST-525-HR-SS Stainless Steel variants available for Harsh Applications
- › Includes ST-001 Inline Tee Assembly
- › Simultaneously measures Light Loss to Determine Sensor Cleanliness



Item	ST-525	ST-525-HR
Part Number	50665	50914
Fluorescein Range	0-60ppb, ±0.2ppb	0-500ppb
4-20mA SPAN	20mA SPAN value adjustable to less than the MAX range via uPyxis® App	
Installation	ST-001 3/4 inch FNPT Glue and Thread Inline Tee Assembly (INCLUDED)	
Outputs	Isolated 4-20mA Analog and Isolated RS-485 Modbus Digital for connection to any Controller, PLC or DCS	
Operational Pressure	100psi (6.9Bar)	
Operational Temperature	4-49 °C (40-120 °F)	
Rating	IP-67	
Regulation	CE, RoHS	



ST-540 SERIES

Plastic & Stainless Steel Inline NDSA Sensors.

Built for those with a desire to evaluate this unique fluorescent tracer for high pressure boiler water tracing applications. The ST-540 Series offer direct measurement of NDSA (Napthenic Disulfonic Acid CAS# 1655-29-4).

0-20ppb

0-500ppb



KEY FEATURES

- › Internal Compensation for Color & Turbidity for True NDSA Value
- › UPVC and Stainless Steel Options Available
- › Built to Evaluate NDSA for High Pressure Boiler Water Tracing Applications
- › Simultaneously measures Light Loss to Determine Sensor Cleanliness
- › Bluetooth® Enabled with MA-WB or PowerPack Series Adapters
- › Wireless Configuration, Calibration, Diagnostics and Data Download via uPyxis®
- › 4-20mA and RS-485 Modbus Outputs for Direct Connection to Any Receiving Device



Item	ST-540A	ST-540SS	ST-540SS-N
Part Number	50621	50667	50694
NDSA Range	0-500ppb	0-500ppb	0-20ppb
Wet Material	UPVC	304 Stainless Steel	304 Stainless Steel
Installation	ST-001 3/4 inch FNPT Tee Assembly	3/4 inch FNPT	
Operational Pressure	100psi (6.9Bar)	290psi (20Bar)	
Operational Temperature	4-49 °C (40-120 °F)		
Outputs	Isolated 4-20mA Analog and Isolated RS-485 Modbus Digital for connection to any Controller, PLC or DCS		
Rating	IP-67		
Regulation	CE, RoHS		

ST-590 SERIES

Optical Measurement of Fluorescent Polymer.

A proprietary design that offers cutting-edge, optical measurement of Fluorescent (Tagged) Polymer. This series compensates for Color, Turbidity and PTSA overlap interference while providing cleanliness diagnostics.

0-20ppm

0-200ppm



KEY FEATURES

- › Automatic Compensation for Color and Turbidity
- › Bluetooth® Enabled with MA-WB or PowerPack Series Adapters
- › Wireless Configuration, Calibration, Diagnostics and Data Download via uPyxis®
- › ST-588SS and ST-590SS Stainless Steel Options Available
- › 4-20mA and RS-485 Modbus Outputs for Direct Connection to Any Receiving Device



Item	ST-588	ST-590
Part Number	50692	50690
Fluorescent Polymer Range	0-20ppm	0-20ppm
PTSA Range	0-200ppb	N/A
Installation	ST-001 3/4 inch FNPT Glue and Thread Inline Tee Assembly (INCLUDED)	
Outputs	Isolated 4-20mA Analog and Isolated RS-485 Modbus Digital for connection to any Controller, PLC or DCS	
Operational Pressure	100psi (6.9Bar)	
Operational Temperature	4-49 °C (40-120 °F)	
Rating	IP-67	
Regulation	CE, RoHS	



ST-600 SERIES

Inline Sensors for Disinfectant Measurement.

The ST-600 Series measures mass/mass concentration of Chlorine content in Sodium Hypchlorite (Bleach) and Chlorine Dioxide. Other variants provide measurement of Acidified Sodium Chlorite (ASC), Chlorine and Monochloramine.

0-16% Chlorine for Bleach

0-2% Chlorine for Bleach

0-5,000ppm MCA

0-3,500ppm ClO2

0-100ppm ClO2

0-1,200ppm ASC

0-400ppm Cl



KEY FEATURES

- › Temperature Compensation (RTD) of Oxidant Concentration & Temp. Output Signal
- › Direct-Read Technology without Dilution or Reagent
- › Long Maintenance & Calibration Cycle (6 Months)
- › 3/4 inch NPT Tee or 1/4 inch Teflon Tubing Installation



Item	ST-600	ST-601	ST-604
Part Number	50231	50232	50233
Measurement	% Chlorine for Bleach	High Range ClO2	% Chlorine for Bleach
Range	0-16%	0-3,500ppm	0-2%

Item	ST-605	ST-606	ST-607	ST-608
Part Number	54148	59433	50670	53638
Measurement	Low Range ClO2	Acidified Sodium Chlorite	Mid Range Chlorine	Monochloramine
Range	0-100ppm	0-1,200ppm	0-400ppm	0-5,000ppm

Item	General Specifications
Installation	3/4 inch NPT Tee or 1/4 inch Teflon Tubing Installations
Outputs	Isolated 4-20mA Analog and Isolated RS-485 Modbus Digital for connection to any Controller, PLC or DCS
Operational Pressure	100psi (6.9Bar)
Operational Temperature	33.8-131 °F (1-50 °C)
Rating	IP-67
Regulation	CE, RoHS

STAINLESS STEEL SENSORS

Stainless Steel Sensor Variants Available.

304 Stainless Steel variants of our standard sensor offering allows for operation in higher temperature and higher pressure applications.



Item	Measurement	Range
ST-500SS	PTSA	0-300ppb (Default)
ST-500RO-SS	PTSA for Reverse Osmosis	0-40ppb
ST-525SS	Fluorescein for Boiler Applications	0-60ppb
ST-525SS-HR	High Range Fluorescein for Boiler & Closed Loop Applications	0-500ppb
ST-540SS	NDSA	0-500ppb
ST-540SS-HR	High Range NDSA	0-2,500ppb
ST-565TSS	Tolytriazole	0-10ppm
ST-587SS	PTSA + Turbidity	0-200ppb / 0-200NTU
ST-588SS	PTSA + Fluorescent Polymer	0-200ppb / 0-20ppm
ST-590SS	Fluorescent Polymer	0-20ppm
ST-730SS	Turbidity	0-100NTU
HM-500SS	Oil-In-Water Content	0-10ppm
HM-510SS	Oil-In-Water Content	0-1,000ppm
HM-520SS	Oil-In-Water Content	0-100ppm
EM-500SS	Chlorophyll-A (Algae)	0-50ppb

Item	General Specifications
Sensor Build Material	304 Stainless Steel
Upper Temperature Limit	120 °F (49 °C)
Upper Pressure Limit	290psi (20Bar)
Installation	3/4 inch FNPT Direct Thread
Outputs	Isolated 4-20mA Analog and Isolated RS-485 Modbus Digital for connection to any Controller, PLC or DCS



ST-X00-SS-T SERIES

Drop-In, Tee-Ready Stainless Steel Sensors.

The ST-600 Series measures mass/mass concentration of Chlorine content in Sodium Hypchlorite (Bleach) and Chlorine Dioxide. Other variants provide measurement of Acidified Sodium Chlorite (ASC), Chlorine and Monochloramine.



ST-750 SERIES

APHA/Hazen Color Sensors for Drinking & Process Water.

Uniquely designed to measure real-time color in water for use in municipal, industrial and environmental applications. Utilizes the APHA/Hazen Platinum-Cobalt method to measure the color in the sample water.

0.10–30 Degrees (ppm Pt-Co)



Item	Measurement	Range
ST-500SS-T	PTSA	0–300ppb (Default)
ST-525SS-T	Fluorescein for Boiler Applications	0–60ppb
ST-525SS-HR-T	High Range Fluorescein for Boiler & Closed Loop Applications	0–500ppb
ST-540SS-HR-T	High Range NDSA	0–2,500ppb
ST-565TSS-T	Tolytriazole	0–10ppm
ST-587SS-T	PTSA + Turbidity	0–200ppb / 0–200NTU
ST-588SS-T	PTSA + Fluorescent Polymer	0–200ppb / 0–20ppm
ST-720SS-T	Conductivity	1–100,000µS/cm
ST-726SS-T	Conductivity	10–300,000µS/cm
ST-730SS-T	Turbidity	0–100NTU
ST-730BSS-T	Turbidity	0–1,000NTU
HM-500SS-T	Oil-In-Water	0–10ppm
HM-520SS-T	Oil-In-Water	0–100ppm
ST-750SS-T	Hazen Color	0.1–30 Degrees Platinum/Cobalt in Water

Item	General Specifications
Sensor Build Material	304 Stainless Steel
Upper Temperature Limit	120 °F (49 °C)
Upper Pressure Limit	290psi (20Bar)
Installation	ST-009 Stainless Steel Tee Assembly ¾ inch Threaded Ports
Outputs	Isolated 4-20mA Analog and Isolated RS-485 Modbus Digital for connection to any Controller, PLC or DCS

KEY FEATURES

- › Fully Integrated 4-20mA and RS-485 Modbus Output Signals
- › Bluetooth® Enabled with MA-WB or PowerPACK Bluetooth® Adapters
- › Wireless Cleaning & Calibration via uPyxis® App
- › UPVC or Stainless Steel Variants Available



Item	ST-750	ST-750SS-T
Part Number	53501	55392
Material	UPVC	316L Stainless Steel
Installation	ST-001 Tee 3/4 NPT - Provided	ST-007 or ST-009 - Sold Separately
Pressure	100psi (6.9Bar)	290psi (20Bar)
Target	APHA / Hazen / Platinum-Cobalt Color	
Output Range	0.10–30 Degrees (ppm Pt-Co); Adjustable up to 500 Degrees MAX	
Accuracy	±2% of the reading or 0.1 Degrees whichever is greater	
Rating	IP-67	
Regulation	CE, RoHS	
Compliance	ASTM-D1209 / ISO-6271	



ST-500W

PTSA Sensor for Alternative Tee Assemblies.

The The ST-500W is a stainless steel inline PTSA Pyxis smart sensor. It is uniquely designed to be directly inserted into the WALCHEM® and alternative fluorometer tee assemblies. The ST-500W is designed for the WALCHEM® tee system.

Walchem® is a registered trademark of Iwaki America (Holliston, MA)

0-300ppb



KEY FEATURES

- › Fully Integrated 4-20mA and RS-485 Modbus Output Signals
- › Bluetooth® Enabled with MA-CR or PowerPACK Bluetooth® Adapters
- › Wireless Cleaning & Calibration via uPyxis® App
- › 304 Stainless Steel Body Material
- › Identical in Internal Design & Function as the World-Class ST-500 Series
- › ST-500W Design allows Drop-In Installation for Walchem® & Alternative Tee Assemblies
- › No Need for Plumbing Modifications
- › Sample Color & Turbidity Compensation



Item	ST-500W
Part Number	58802
PTSA Range	0-200ppb (0-300ppb MAX Configurable via uPyxis®), ±1ppb
Excitation/Emission	LED 365/410nm
Installation	Walchem® Tee or Alternative Fluorometer Tee (Built for Pre-Existing Systems)
Outputs	Isolated 4-20mA Analog and Isolated RS-485 Modbus Digital for connection to any Controller, PLC or DCS
Operational Pressure	up to 100psi (0.7MPa)
Operational Temperature	4-49 °C (40-120 °F)
Rating	IP-67
Regulation	CE, RoHS

FS-SERIES

State-of-the-Art Ultrasonic Flow Meters.

Ideal for flow measurement and are offered in two liquid end materials for standard water and highly corrosive solution applications. Operating on the principle of transit time difference.

0-3,000mL/min

0-10,000mL/min



KEY FEATURES

- › Live Local Display with Real-Time Flow Rate Trend Chart
- › (2) Isolated 4-20mA and (1) RS-485 Modbus-RTU Output
- › Built-In Temperature Sensor for Automatic Compensation
- › Integrated User Defined Flow Rate with PID Output Control for 4-20mA Regulating Valve/Pump
- › Large Color LED Indicator for Operational State
- › Variants for Common Water Flow Measurement & Highly Corrosive Solution Flow Measurement



Item	FS-100	FS-200	FS-101	FS-201
Part Number	54200	54081	58542	51488
Supported Fluid	Liquids (Water)		Corrosive Aqueous Solution	
Rated Flow Range	0-3,000mL/min	0-10,000mL/min	0-3,000mL/min	0-10,000mL/min
Wet End Material	UPVC, PPS Plastic, GF Polymer, Epoxy, Fluorine Rubber		PPS Plastic, GF Polymer, Epoxy, Fluorine Rubber	
Outputs	#1 4-20mA for Flow Rate, #2 4-20mA for Regulating Valve, (1) Isolated RS-485 Modbus RTU			
Sample Inlet Pressure	7.25-100psi (0.05-0.689MPa)			
Sample Inlet/Outlet	½ inch NPT			
Supported Fluid Temperature	4-49 °C (40-120 °F)			
Flow Path Inner Diameter	5mm			
MAX Error	±10mL/min or 1% of the value, whichever is greater			
Power Supply	24VDC, 2W			
Protection	IP65			
Regulation	CE, RoHS			



ST-71XSS SERIES

Exchangeable Electrode Inline pH + ORP Sensors.

The ST-71XSS Series are pH and ORP sensors with a replaceable Electrode Head design for simple sensor maintenance.

0-14pH ±1,500mV



KEY FEATURES

- › Replaceable Electrode Head for Simple Maintenance
- › Accurate and Stable Measurement with Ultra-Low Drift
- › Built-In Transmitter without Pre-amplifier or Meter Head
- › Dual Outputs 4-20mA Isolated Signals or RS-485 Modbus
- › Long-Distance Transmission with Higher Stability and Accuracy
- › Wireless Calibration, Diagnostics, Data Trends via uPyxis® App
- › Bluetooth® Enabled with MA-CR or PowerPack Series Adapters
- › Large Junction Capacity, 3-4X Electrolyte Solution Content
- › Enlarged Platinum Disk and Longer Service Life



Item	ST-710SS	ST-711SS	ST-712SS
Part Number	53030	53031	53032
pH Range	0.00-14.00 with ATC	N/A	0.00-14.00 with ATC
ORP Range	N/A	±1,500mV	±1,500mV
Installation	ST-001 3/4 inch FNPT Tee Assembly		
Operational Pressure	100psi (6.9Bar)		
Operational Temperature	4-49 °C (40-120 °F)		
Outputs	Isolated 4-20mA Analog and Isolated RS-485 Modbus Digital for connection to any Controller, PLC or DCS		
Rating	IP-67		
Regulation	CE, RoHS		

ST-765SS SERIES

The First Generation of Oxidizer + pH Sensors.

The ST-765 Series are stainless steel, multiparameter, membrane-less sensors that determine oxidizer and pH content in water. Offers a replaceable reference electrode that utilizes bare-gold electrochemical detection of the oxidizer.

F-Cl T-Cl ClO₂ Br O₃
 NCL H₂O₂ PAA SO₃ DBNPA



KEY FEATURES

- › Real Time pH + Oxidizer Detection
- › Dual 4-20mA and RS-485 Modbus Outputs for Connection to Any Receiving Device
- › Bluetooth® Enabled with MA-CR or PowerPACKAdapters
- › Wireless Calibration, Diagnostics, Data Trends via uPyxis® App
- › Integrated RTD and pH Compensation up to 9.0 of the Oxidizer Value
- › Replaceable EH-765 Reference Electrode Assembly for Simple Maintenance.



Sensor	Part Number	Analyte(s)	Range(s)
ST-765SS-FCL	53607	Free Chlorine	0.00-5.00ppm
ST-765SS-TCL	53616	Total Chlorine	0.00-5.00ppm
ST-765SS-CLO	53608	Chlorine Dioxide	0.00-5.00ppm
ST-765SS-PAA	53610	Peroxyacetic Acid	0-100ppm
ST-765SS-H2O2	53612	Hydrogen Peroxide	0-200ppm
ST-765SS-O3	53614	Ozone	0-2ppm
ST-765SS-NCL	53623	Monochloramine	0-5ppm
ST-765SS-SO3	53624	Sulfite	0-100ppm
ST-765SS-DBNPA	54267	DBNPA	0-20ppm
ST-765SS-DCL	58444	Free Chlorine + Sulfite	0-5ppm + 0-100ppm
ST-765SS-Br	59643	Bromine	0-5ppm
ST-765SS-TFCL	55994	Total Chlorine + Free Chlorine	0-5ppm + 0-5ppm



ST-766SS SERIES

The Next Generation of Oxidizer + pH Sensors.

Monitor oxidizer, pH, ORP, conductivity, and temperature in real time with one rugged, membrane-free sensor built for the toughest water treatment environments.

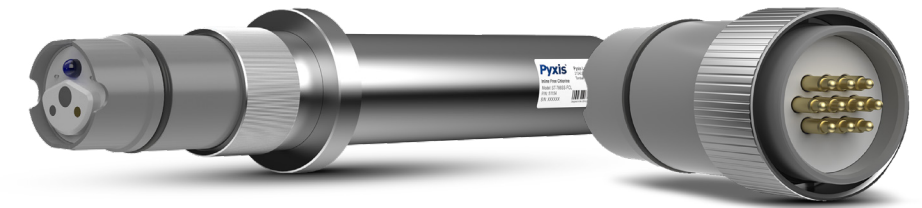
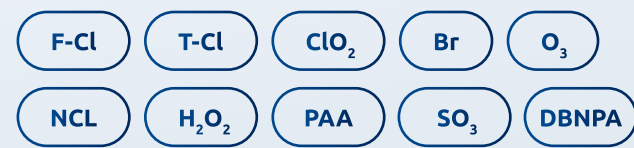

DESCRIPTION

The ST-766SS Series are multi-parameter sensors designed for continuous measurement of various oxidizing species and reducing species in water treatment applications. Each model is identified by its product name ST-766SS followed by a suffix indicating its target analyte. (Free Chlorine, Total Chlorine, Chlorine Dioxide, Bromine, Monochloramine, Peracetic Acid, Hydrogen Peroxide, Sulfite, Ozone and DBNPA 2-2dibromo-3-nitropropionamide). Two specialty combination models are also available including the ST-766SS-TFCL (simultaneous Free & Total Chlorine) and ST-766SS-DCL (simultaneous Free Chlorine and Sulfite for Dechlorination).

All models incorporate additional measurements of pH, ORP, Conductivity, and Temperature for comprehensive process monitoring. Among these, pH and temperature are automatically utilized for oxidizer concentration compensation, while ORP serves as a direct indicator of whether the water environment is in an oxidizing or reducing state. Conductivity is included as an auxiliary parameter, eliminating the need for a separate conductivity sensor.

KEY FEATURES

- › OXILOGIC™ front-loading, replaceable reference electrode, eliminating traditional membrane & gel maintenance.
- › Isolated 4-20mA Analog and Isolated RS-485 Modbus Outputs for connection to ANY Controller, PLC, or DCS.
- › Integrated RTD and pH Compensation up to 9.0+ of the Oxidizer Value.
- › **Addition of Conductivity to the Multiparameter Oxidizer, pH, ORP, Temperature Offering.**



Sensor	Part Number	Analyte(s)	Range(s)
ST-766SS-FCL	51154	Free Chlorine	0.00-5.00ppm
ST-766SS-TCL	51379	Total Chlorine	0.00-5.00ppm
ST-766SS-CLO	55821	Chlorine Dioxide	0.00-5.00ppm
ST-766SS-PAA	54803	Peroxyacetic Acid	0-100ppm
ST-766SS-H2O2	53302	Hydrogen Peroxide	0-200ppm
ST-766SS-O3	54828	Ozone	0-2ppm
ST-766SS-NCL	54731	Monochloramine	0-5ppm
ST-766SS-SO3	58305	Sulfite	0-100ppm
ST-766SS-DBNPA	50484	DBNPA	0-20ppm
ST-766SS-DCL	57300	Free Chlorine + Sulfite	0-5ppm + 0-100ppm
ST-766SS-Br	52743	Bromine	0-5ppm
ST-766SS-TFCL	55659	Total Chlorine + Free Chlorine	0-5ppm + 0-5ppm

Item	ST-766SS Series General Specifications
pH Range	0.00-14.00
pH Precision	±0.01pH
ORP Range	-1,500 - 1,500mV
ORP Precision	±1.0mV ORP
Conductivity Range	0-10,000µS/cm
Conductivity Precision	±5% of Value
Measurement Interval	Continuous
Sensor Response Time	T95≤240s - Oxidant T95≤5s - pH/ORP/Conductivity
Operating Temperature	4-49 °C (40-120 °F)
Inlet Operating Pressure	7.25-87psi (0.05-0.6MPa)
Power Supply	22-26V DC, Power Consumption ~2W
Rating	IP67
Compliance	EPA 334.0 / ISO-7393
Regulation	CE Marked, RoHS, UKCA
Selectivity	Non-Selective, Cross Sensitive to Other Oxidizing Species
Warranty	6 Months - Electrode 13 Months - Sensor Body
Typical Electrode Life	2 Years
Cables Included	MA-1.5CR (1.5m Flying Lead Cable with 8PIN Male Adapter) MA-4.9CR (1.5m Bulkhead Cable with 8PIN Male/Female Adapter)



ST-765P SERIES

CPVC Non-Wet Chemistry Oxidizer + pH Sensors.

The ST-765P series are multparameter, membrane-less sensors based on unique electrochemical principles to determine oxidizers plus pH and temperature. Like the ST-765, the ST-765P offers a replaceable front-loading electrode assembly.

- F-Cl
- T-Cl
- NCL
- PAA
- O₃



KEY FEATURES

- › Real-Time pH + Oxidizer Detection
- › Dual 4-20mA and RS-485 Modbus Outputs
- › Installed into the FR-50 Flow Reservoir
- › Integrated RTD & pH Compensation up to 9.0+
- › Replaceable Front-Loading EH-765-01 Reference Electrode Assembly



Sensor	Part Number	Analyte(s)	Range(s)
ST-765P-FCL	53619	Free Chlorine	0.00-5.00ppm
ST-765P-TCL	57619	Total Chlorine	0.00-5.00ppm
ST-765P-CLO	58861	Chlorine Dioxide	0.00-5.00ppm
ST-765P-DCL	59907	Free Chlorine + Sulfite	0-5ppm + 0-100ppm
ST-765P-NCL	55544	Monochloramine	0-5ppm
ST-765P-PAA	50992	Peroxyacetic Acid	0-100ppm
ST-765P-O3	54485	Ozone	0-2ppm

XT-500

Self-Cleaning, Stainless Steel Inline PTSA Sensor.

The next generation of the proven ST-500 Series PTSA fluorometer platform. Incorporating a self-cleaning wiper and stainless steel design, the XT-500 is ideal for cooling and process water applications for chemical dosing control.

- 0-500ppb



KEY FEATURES

- › 316 Stainless Steel Construction with Stainless Steel Tee Installation Assemblies
- › Integrated Cleaning Wiper for Effective Removal of Deposits and Fouling from Optical Window
- › Internal Compensation for Color & Turbidity
- › 8PIN Cable Format for use with the MA-CR Bluetooth® Adapter
- › 4-20mA and RS-485 Modbus Communication
- › Expanded 0-500ppb PTSA Range



Item	XT-500
Part Number	52267
PTSA Range	0-500ppb
Excitation/Emission	LED 365/410nm
Material	316 Stainless Steel
Installation	ST-007 Stainless Steel Tee ¼ inch OD Compression or ST-009 Stainless Steel Tee ¾ inch FNPT Threaded Ports
Outputs	Isolated 4-20mA Analog and Isolated RS-485 Modbus Digital for connection to any Controller, PLC or DCS
Operational Pressure	100psi (6.9Bar)
Operational Temperature	4-49 °C (40-120 °F)
Rating	IP-67
Regulation	CE, RoHS



ST-772 SERIES

Plastic or 316L Stainless Steel Luminescent Dissolved Oxygen.

Optical Luminescent DO Sensors based on the principle of 'Fluorescence Quenching' to determine dissolved oxygen content in water. Extremely low Blue/Red Light detection, with inline and submersible installation options.

0.004–20mg/L (ppb)



KEY FEATURES

- › 0.004–20mg/L Measurement Range
- › No Membrane Replacement or Electrolyte Replacement
- › Simple DO Cartridge Replacement every 2 Years
- › Built-In Temperature & Pressure Sensor with Automatic Compensation
- › Built-In Transmitter without Pre-Amplifier or Meter Head
- › Isolated 4-20mA Analog and RS-485 Modbus Communication
- › Wireless Calibration, Diagnosis, Data Trend via uPyxis® app when used with MA-CR
- › Slope Calibration with Air or Air Saturated Water
- › Zero Calibration with 5% Sulfite Solution or Nitrogen Gas
- › Submersible (ST-772/P) or Inline Pipe Tee (ST-772T/T-P) Installation Versions Available



Item	ST-772	ST-772T	ST-772P	ST-772T-P
Part Number	53703	53719	53720	53721
Installation Method	Submerged Installation	Bypass/Inline Installation	Submerged Installation	Bypass/Inline Installation
Wet Material	316L Stainless Steel & Polycarbonate		CPVC & Titanium	
Dissolved Oxygen Range	0.004–20mg/L or 0–200% Saturation or 0–500mbarP02; ±0.1mg/L or ±1% whichever is greater			
Operational Pressure	145psi			
Operational Temperature	0–45 °C (32–113 °F)			
Outputs	Isolated 4-20mA Analog and Isolated RS-485 Modbus Digital for connection to any Controller, PLC or DCS			
Rating	IP-67 / IP-68			
Regulation	CE, RoHS, USEPA 40CFR Part 136.3			

ST-773

Optical Luminescent Dissolved Oxygen Sensor.

A simplified optical luminescent Dissolved Oxygen (DO) sensor, made of CPVC, that measures at a range of 0.004–20mg/L (ppb). Built for inline or submersible installations.

0.004–20mg/L (ppb)



KEY FEATURES

- › 0.004–20mg/L Measurement Range with Ultra-Low Drift
- › Simple PTFE Film DO Cartridge Replacement
- › Built-In Temperature Sensor with Automatic Compensation
- › Built-In Transmitter without Preamplifier or Meter Head
- › Isolated 4-20mA Analog and RS-485 Modbus Communication
- › CPVC Body - Lightweight & Corrosion Resistant
- › Submersible or Inline Installations available using our Submersion or Inline Adapters
- › Meter Tail = ¾ inch NPT Outer Diameter Threading for Simple Installation



Item	ST-773
Part Number	53709
Body Material	CPVC
Installation	Submerged and Inline Installation
Dissolved Oxygen Range	0.004–20mg/L or 0–200% Saturation
Outputs	Isolated 4-20mA Analog and Isolated RS-485 Modbus Digital for connection to any Controller, PLC or DCS
Operational Pressure	75psi
Operational Temperature	0–45 °C (32–113 °F)
Rating	IP-67
Regulation	CE, RoHS
Compliance	USEPA 40CFR Part 136.3, ISO 17289:2014



ST-774

Ultra-Low Luminescent Dissolved Oxygen Sensor.

The ST-774 is an ultra-low range Dissolved Oxygen (DO) sensor that has a lower detection limit of 0.4ppb (µg/L). Offers an easily replaceable, front-loading DO membrane cap with a 2 year service life.

0.4–2,000µg/L (ppb)



KEY FEATURES

- › 0.0–2,000µg/L Measurement Range with 0.1µg/L Limit of Detection (LOD)
- › Built-In Temperature and Pressure Sensors
- › Accurate and Stable Measurement with Ultra-Low Drift
- › Built-In Transmitter without the need of using a Pre-Amplifier or Meter Head
- › Dual Outputs Isolated 4-20mA Signal and RS-485 Modbus
- › Long Distance Transmission with Higher Stability and Accuracy
- › Zero-Point Calibration with Nitrogen and Slope Calibration in O₂ containing Calibration Gas
- › 316L Stainless Steel Sensor Body



Item	ST-774
Part Number	53715
Dissolved Oxygen Range	0.0–2,000µg/L (ppb); ±0.3µg/L or ±1% whichever is greater
Installation / Material	¼ inch OD Swagelok / 316L Stainless Steel
Calibration	High Point: 0.1% Oxygen in Nitrogen Gas Zero: 99.999% Nitrogen Gas or 5% Catalyzed Sodium Sulfite (2-4 Hour Soak)
Outputs	Isolated 4-20mA Analog and Isolated RS-485 Modbus Digital for connection to any Controller, PLC or DCS
Operational Pressure	145psi (10Bar)
Operational Temperature	0–45 °C (32–113 °F)
Rating	IP-67
Regulation	CE, RoHS
Compliance	USEPA 40CFR Part 136.3, ISO 17289:2014

RT-50

Refractive Index + BRIX Inline Refractometer.

The RT-50 measures the concentration of Sugar Content (%BRIX) and Refractive Index Value (%nD) with one robust, stainless steel sensor with the ability to created User Defined Liquid %.

%BRIX

%nD



KEY FEATURES

- › User Defined Product Concentration Curve Entry via uPyxis®
- › User Customizable 4-20mA Concentration Output Ranges with uPyxis®
- › RS-485 Modbus RTU Output of Temperature, nD and Other Diagnosis Parameters
- › 4-20mA Output of Sample Temperature & the Unit of Display selected via Screen Interface
- › Local Display and Button Interface
- › Optional 110/220VAC - 24VDC Wall Outlet Powered for Independent Operation
- › Bluetooth® Enabled with MA-CR Bluetooth® Adapter
- › Stainless Steel Tri-Clamp Flow Cell Assembly with ¾ inch NPT Flange
- › Automatic Cleaning with RT-Series Ultrasonic Cleaning Module Kit



Item	RT-50
Part Number	10013
Refractive Index Range	1.3200–1.4000 ±0.0002
BRIX Range	0.00–38.00% ±0.2%
Temperature Range	-20–80 °C
Sample Temperature	14–158 °F (-10–70 °C)
MAX Sample Pressure / Flow	≤142psi (0.98MPa) / <13.5GPM (9.8ft/s)
Wet Materials	Sapphire Lens, 316L Stainless Steel Body
Signal Outputs	Isolated 4-20mA Analog and Isolated RS-485 Modbus Digital for connection to any Controller, PLC or DCS
Protection	IP67
Regulation	CE / RoHS



RT-100 Multiparameter Inline Refractometer.

A unique inline refractometer that measures Refractive Index of a liquid sample and provides direct-reading of highly accurate concentration values for a wide variety of water and process related applications.

- %BRIX
- %nD
- %AVS
- %MEG
- %MPG



KEY FEATURES

- › 4-20mA Output of Sample Temperature & the Unit of Display selected via Screen Interface
- › RS-485 Modbus RTU Output of Temperature, Refractive Index and Other Diagnosis
- › Local Display and Button Interface
- › Optional 110/220VAC - 24VDC Wall Outlet Powered for Independent Operation
- › Bluetooth® Enabled with MA-CR Bluetooth® Adapter
- › Convenient Stainless Steel Tri-Clamp Flow Cell Assembly with ¾ inch NPT Flange
- › Automatic Cleaning with RT-Series Ultrasonic Cleaning Module Kit



Item	RT-100
Part Number	55105
Refractive Index Range	1.3000-1.5100 ±0.0002
BRIX Range	0.00-85.00% ±0.2%
Glycol Range	0.00-100.00% Mono-Ethylene Glycol or Mono-Propylene Glycol ±0.2%
Advanced Low Viscosity Fluid	0.00-100.00% ±0.2%
Temperature Range	-20-80 °C
MAX Sample Pressure / Flow	≤142psi (0.98MPa) / <13.5 GPM (9.8ft/s)
Wet Materials	Sapphire Lens, 316L Stainless Steel Body
Protection	IP67
Regulation	CE/RoHS

RT-200 High Temperature/Pressure Inline Refractometer.

The RT-200 is particularly suitable for sugar production and other high-temperature processes. Offering measurement of Refractive Index of a liquid sample.

- %BRIX
- %nD
- %AVS
- %MEG
- %MPG

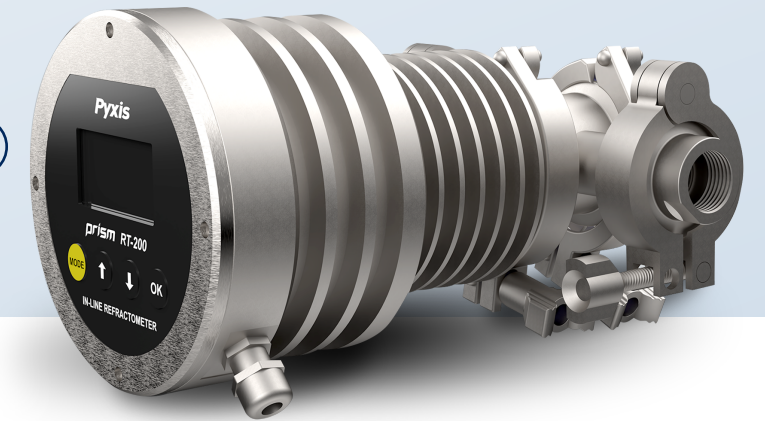

KEY FEATURES

- › Operational Temperature as High as 248 °F (120 °C)
- › 4-20mA Output of Sample Temperature & the Unit of Display selected via Screen Interface
- › RS-485 Modbus RTU Output of Temperature, Refractive Index and Other Diagnosis
- › Local Display and Button Interface
- › Optional 110/220VAC - 24VDC Wall Outlet Powered for Independent Operation
- › Bluetooth® Enabled with MA-CR Bluetooth® Adapter
- › Convenient Stainless Steel Tri-Clamp Flow Cell Assembly with ¾ inch NPT Flange
- › Automatic Cleaning with RT-Series Ultrasonic Cleaning Module Kit



Item	RT-200
Part Number	57124
Refractive Index Range	1.3000-1.5100 ±0.0002
BRIX Range	0.00-85.00% ±0.2%
Glycol Range	0.00-100.00% Mono-Ethylene Glycol or Mono-Propylene Glycol ±0.2%
Advanced Low Viscosity Fluid	0.00-100.00% ±0.2%
Sample Temperature	-4-248 °F (-20-120 °C)
MAX Sample Pressure / Flow	≤142psi (0.98MPa) / <13.5 GPM (9.8ft/s)
Wet Materials	Sapphire Lens, 316L Stainless Steel Body
Protection	IP67
Regulation	CE/RoHS



RT-110

Bypass Flow Installation Inline Refractometer.

The RT-110 is an online digital refractometer that measures Refractive Index of a liquid sample. Designed for bypass flow installations, this simplified RT-Series variant has no display or button interface.

- %BRIX
- %nD
- %AVS
- %MEG
- %MPG



KEY FEATURES

- › User Customizable 4-20mA Concentration Output Ranges via the uPyxis® App
- › RT-110 Convenient Stainless Steel Tri-Clamp Flow Cell Assembly with 3/4 inch NPT Flange
- › RT-110 is designed to Integrate into Data Center Coolant Monitoring Systems
- › RS-485 Modbus RTU Output of Temperature, Refractive Index and Other Diagnostics
- › 4-20mA Output of Optical Cell Temperature and the Unit Selected via the uPyxis® app
- › Bluetooth® Enabled when used with MA-CR Bluetooth® Adapter
- › User-Defined Custom Curve Setup Capable via uPyxis® app
- › Sturdy 316L Stainless Steel Construction and Suitable for Harsh Application Environments

Item	RT-110
Part Number	59207
Refractive Index Range	1.31700-1.5100 ±0.0001
BRIX Range	0.00-85.00% ±0.1%
Glycol Range	0.00-100.00% Mono-Ethylene Glycol or Mono-Propylene Glycol ±0.1%
Temperature Range	-20-80 °C
Installation	Tri-Clamp Flow Assembly for Bypass Flow Installation
MAX Sample Pressure / Flow	≤142psi (0.98MPa) / <13.5 GPM (9.8ft/s)
Wet Materials	Sapphire Lens, 316L Stainless Steel Body
Protection	IP67
Regulation	CE/RoHS

RT-110L

Tank Wall Installation Inline Refractometer.

The RT-110L is an online digital refractometer that measures Refractive Index of a liquid sample. Designed for tank side wall installations, this simplified RT-Series variant has no display or button interface.

- %BRIX
- %nD
- %AVS
- %MEG
- %MPG



KEY FEATURES

- › User Customizable 4-20mA Concentration Output Ranges via the uPyxis® App
- › RRT-110L Convenient Stainless Steel Sanitary Coupler for Tank Installation - 2.5inch
- › RT-110L is specifically designed for Direct Installation on the Tank
- › RS-485 Modbus RTU Output of Temperature, Refractive Index and Other Diagnostics
- › 4-20mA Output of Optical Cell Temperature and the Unit Selected via the uPyxis® app
- › Bluetooth® Enabled when used with MA-CR Bluetooth® Adapter
- › User-Defined Custom Curve Setup Capable via uPyxis® app
- › Sturdy 316L Stainless Steel Construction and Suitable for Harsh Application Environments

Item	RT-100
Part Number	55105
Refractive Index Range	1.3000-1.5100 ±0.0002
BRIX Range	0.00-85.00% ±0.2%
Glycol Range	0.00-100.00% Mono-Ethylene Glycol or Mono-Propylene Glycol ±0.2%
Temperature Range	-20-80 °C
Installation	Sanitary Clamp Coupling for Tank Side Wall Installation
MAX Sample Pressure / Flow	≤142psi (0.98MPa) / <13.5 GPM (9.8ft/s)
Wet Materials	Sapphire Lens, 316L Stainless Steel Body
Protection	IP67
Regulation	CE/RoHS



CR-SERIES

Linear Polarization Resistance Inline Corrosion Rate Sensors.

The CR-Series Corrosion Rate Sensors are ideal for cooling and process water treatment monitoring, utilizing the Linear Polarization Resistance method to produce a raw signal.



KEY FEATURES

- › Battery or 24VDC Power Supply Options for Portability or Direct Connection to Controller
- › Anti-Electromagnetic Interference Design with Stainless Steel Sensor Body
- › Three O-Ring Grooves positioned on Sensor Body for Insertion Depth Control
- › Configuration via uPyxis® App
- › Default Ranges and Alloy Factor Assigned with Metallurgy Selection on uPyxis® App
- › Accurately Measure Generalized or Localized Corrosion Rate
- › 2.0MPY and 1.0MPY Corrosion Calibration Check Caps Provided

Item	CR-200	CR-300
Part Number	51006	51007
Power Supply	3.6V ER26500 Battery	24VDC, 2W
General Corrosion Range	0.001–10.000 (MPY Default based on Metallurgy); 0.001–995 (MAX MPY Customizable via uPyxis®)	
Localized Corrosion Range	0.001–100 (Index Customizable via uPyxis®)	
Alloy Factor	0–3 (Adjustable Default Assigned via uPyxis® Metallurgy UNS Code)	
Conductivity Compensation	10–10,000µS/cm	
Installation	Flow Cell with 1inch NPT	
Outputs	4-20mA Analog and RS-485 Modbus Digital for connection to any Controller, PLC or DCS	
Operational Pressure	Up to 100psi (6.9Bar)	
Operational Temperature	-20–50 °C	
Rating	IP-65	
Regulation	CE, RoHS	

CR-301

High Temperature/Pressure Inline Corrosion Rate Sensor.

The CR-301 is ideal for extreme environmental and sample conditions in process application monitoring where robustness and affordability are a must. The sensor utilizes LPR method to produce a raw signal.

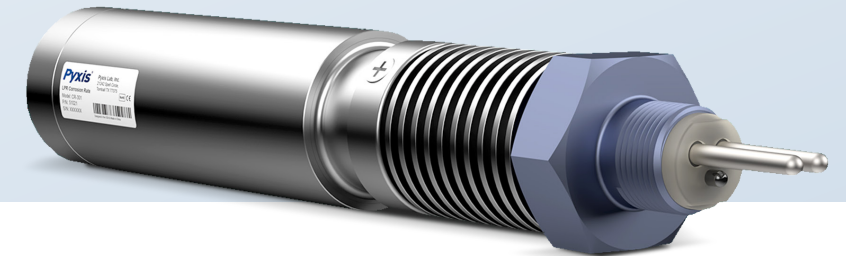

KEY FEATURES

- › Anti-Electromagnetic Interference Design with Stainless Steel Sensor Body
- › Dual 4-20mA and RS-485 Modbus Outputs for Connection to Any Receiving Device
- › Integrated Cooling Fin Design for High Temperature Applications
- › Bluetooth® Ready when used with MA-CR Bluetooth® Adapter
- › Default 4-20mA Output Scales and Alloy Factors assigned for Selected Metallurgy on uPyxis®
- › Customization of Alloy Factor and Upper MPY / Index (20mA) Scale on uPyxis®
- › Ultra-Low General Corrosion Rate Detection down to 0.001MPY

Item	CR-301
Part Number	51021
Power Supply	24VDC, 2W
General Corrosion Range	0.001–995 MPY
Localized Corrosion Range	0.001–100 MPY
Alloy Factor Range	0–3 (Adjustable Default Assigned via uPyxis® Metallurgy UNS Code)
Output	RS-485 and 4-20mA Dual Output
Installation	¾ inch NPT
Enclosure Material	Titanium + PEEK
Operating Pressure	Up to 500psi (34.5Bar)
Operating Temperature	-10–240 °C (14–464 °F)
Protection	IP68
Regulation	CE/RoHS



LIQUID LEVEL SENSORS



Pyxis Lab's liquid level sensor lineup—featuring ultrasonic, radar, and pressure-based technologies—provides reliable, real-time level measurement across a wide range of applications and environments. Designed for flexibility and ease of integration, these sensors deliver accurate data in challenging conditions, from open tanks to pressurized systems, helping operators maintain visibility, optimize processes, and reduce manual monitoring.



LS-200 Ultrasonic 24VDC Liquid Level Sensor.

The LS-200 is a non-contact continuous ultrasonic liquid level sensor that provides measurement up to 106 inches (2.7m).



KEY FEATURES

- › Embedded Transmitter 4-20mA and RS-485 Modbus Outputs
- › Bluetooth® Enabled for Rapid Wireless Configuration via uPyxis®
- › 24VDC Power Supply with Smart Switch Capability
- › PVDF Transducer / 6P Polycarbonate Enclosure
- › 10ft Waterproof 7PIN Quick Adapter/Flying Lead Cable
- › Automatic Temperature & Electro-magnetic Noise Compensation



Item	LS-200
Part Number	54011
Range	4-106 inches (0.1-2.7m)
Accuracy	±0.15% of the Range
Dead Zone	4 inches (10cm)
Configuration	via uPyxis® App
Power Supply	24VDC, 2W MAX
Signal Output	Bluetooth® 5.0, 4-20mA, RS-485 Modbus
Enclosure Rating	IP67
Installation	1 inch MNPT
Operational Temp. / Pressure	14-122 °F (-10-50 °C) / 14-30psi (0.1-0.2MPa)
Regulation	CE/RoHS

LS-202 SERIES Ultrasonic Battery/24VDC Liquid Level Sensor.

The LS-202 is a non-contact continuous ultrasonic liquid level sensor that provides measurement up to 106 inches (2.7m). Offers dual power supply (batteries or 24VDC).



KEY FEATURES

- › Dual Power Supply (4) AA Batteries / 24VDC with Smart Switch Capability
- › Live Local Display with Button Interface
- › Embedded Transmitter 4-20mA and RS-485 Modbus Outputs
- › Bluetooth® Enabled for Rapid Wireless Configuration via uPyxis®
- › PVDF Transducer / 6P Polycarbonate Enclosure
- › 10ft Waterproof 7PIN Quick Adapter/Flying Lead Cable
- › Automatic Temperature & Electro-magnetic Noise Compensation



Item	LS-202	LS-202EX
Part Number	54002	54008
Range	4-106 inches (0.1-2.7m)	4-106 inches (0.1-2.7m)
Accuracy	±0.15% of the Range	±0.15% of the Range
Dead Zone	4 inches (10cm)	4 inches (10cm)
Configuration	via uPyxis® App	via uPyxis® App
Power Supply	(4) AA Batteries / 24VDC, 2W MAX	(4) AA Batteries / 24VDC, 2W MAX
Signal Output	Bluetooth® 5.0, 4-20mA, RS-485 Modbus	Bluetooth® 5.0, 4-20mA, RS-485 Modbus
Enclosure Rating	IP67	IP67
Installation	1 inch MNPT	1 inch MNPT
Operational Temp. / Pressure	14-122 °F (-10-50 °C) / 14-30psi (0.1-0.2MPa)	14-122 °F (-10-50 °C) / 14-30psi (0.1-0.2MPa)
Regulation	CE/RoHS	CE / RoHS / Class I & II / Div 2 Class III / Div 1 & 2



LSR-801 SERIES

Radar 24VDC Liquid Level Sensor.

The LSR-801 Series are W-Band FMCW frequency radar level transmitters, providing continuous level measurement up to 591 inches with LoRa Ready variants for long-distance data transmission.



KEY FEATURES

- › Radar Liquid Level Measurement up to 15m
- › Embedded Transmitters 4-20mA and RS-485 Modbus Outputs
- › LoRa (Long-Range Radio) Implemented in the LSR-801L
- › 24VDC Power Supply with Smart Switch Capability
- › PVDF Transducer / 6P Polycarbonate Enclosure
- › 10ft Waterproof 7PIN Quick Adapter/Flying Lead Cable



Item	LSR-801	LSR-801L
Part Number	51959	54027
Range	2-591in (0.05-15m)	2-591in (0.05-15m)
Accuracy	±2mm	±2mm
Dead Zone	2 inches (5cm)	2 inches (5cm)
Configuration	via uPyxis® App	via uPyxis® App
Power Supply	24VDC, 2.5W MAX	24VDC, 2.5W MAX
Radio Output	N/A	LoRa (Long Range Radio)
Signal Output	Bluetooth® 5.0, 4-20mA, RS-485 Modbus	Bluetooth® 5.0, 4-20mA, RS-485 Modbus
Enclosure Rating	IP66	IP67
Installation	1 inch MNPT	1 inch MNPT
Operational Temp. / Pressure	14-122 °F (-10-50 °C) / 14-30psi (0.1-0.2MPa)	14-122 °F (-10-50 °C) / 14-30psi (0.1-0.2MPa)
Regulation	CE/RoHS	CE / RoHS / Class I & II / Div 2 Class III / Div 1 & 2

LSR-803 SERIES

Radar Battery/24VDC Liquid Level Sensor.

The LSR-803 Series are W-Band FMCW frequency radar level transmitters, providing continuous level measurement up to 591 inches with LoRa Ready variants for long-distance data transmission.



KEY FEATURES

- › Radar Liquid Level Measurement up to 15m
- › Live Local Display with Button Interface
- › Embedded Transmitters 4-20mA and RS-485 Modbus Outputs
- › LoRa (Long-Range Radio) Implemented in the LSR-803L
- › (4) AA Battery / 24VDC Power Supply with Smart Switch Capability
- › PVDF Transducer / 6P Polycarbonate Enclosure
- › 10ft Waterproof 7PIN Quick Adapter/Flying Lead Cable



Item	LSR-803	LSR-803L
Part Number	54002	54008
Range	2-591in (0.05-15m)	2-591in (0.05-15m)
Accuracy	±2mm	±2mm
Dead Zone	2 inches (5cm)	2 inches (5cm)
Configuration	via uPyxis® App	via uPyxis® App
Power Supply	(4) AA Batteries / 24VDC, 2.5W MAX	(4) AA Batteries / 24VDC, 2.5W MAX
Radio Output	N/A	LoRa (Long Range Radio)
Signal Output	Bluetooth® 5.0, 4-20mA, RS-485 Modbus	Bluetooth® 5.0, 4-20mA, RS-485 Modbus
Enclosure Rating	IP66	IP67
Installation	1 inch MNPT	1 inch MNPT
Operational Temp. / Pressure	14-122 °F (-10-50 °C) / 14-30psi (0.1-0.2MPa)	14-122 °F (-10-50 °C) / 14-30psi (0.1-0.2MPa)
Regulation	CE/RoHS	CE / RoHS / Class I & II / Div 2 Class III / Div 1 & 2



LG-SERIES

LoRa Receiver & Converters for LSR-Series Level Sensors.

Receiver devices meant to capture data via LoRa (Long-Range Radio) communications and convert the received data into RS-485 Modbus and 4-20mA outputs for connection to multiple devices.



DESCRIPTION

The LG-100 and LG-200 are LoRa enabled receiver device designed to capture data via LoRa (Long Range Radio) communications and convert the received data into Modbus RS-485 and 4-20mA outputs for connection to multiple device formats. The LG-Series LoRa receivers have a 1.3-inch OLED display and 4 buttons for easy wireless configuration with the uPyxis® 2.0 app for Mobile and Desktop devices enabling rapid deployment in the field.

The LG-Series are powered by a 24 VDC/1.0W external power supply and is ideal for use with commonly used OEM controllers, PLC or DCS systems. Designed to offer a wireless data communication solution for critical industrial applications with great flexibilities yet affordable cost. These devices allows direct radio connection to any Pyxis LoRa integrated sensor as well as to the Pyxis LG-50 LoRa converter, enabling wireless radio use with any standard non-LoRa Pyxis sensor(s).

Item	LG-100	LG-200
Part Number	28903	26652
Power Supply	24VDC, 1W MAX	24VDC, 1W MAX
Bluetooth® Connection	Bluetooth® 5.0 for use with uPyxis®	Bluetooth® 5.0 for use with uPyxis®
Radio Range	up to 1.8km (Line of Sight)	up to 1.8km (Line of Sight)
Wired Output	(1) 4-20mA, (up to 4) RS-485 Modbus	(4) 4-20mA
Installation	LG-MB-002 Wall Mounting Bracket	LG-MB-002 Wall Mounting Bracket
Display	1.3 inch OLED Display	1.3 inch OLED Display

PRL-100

Portable Radar Liquid Level Sensor.

A portable, high-precision FMCW Radar Level Transmitter designed for non-contact liquid measurement. With NFC Tank ID, LoRa Communication and Bluetooth® Configuration, the PRL-100 offers smart, wireless monitoring for chemical and industrial applications.



KEY FEATURES

- › Unlimited Container NFC Tag Configuration. Tap, Read, Go.
- › Radar Liquid Level Measurement up to 15m (±2mm)
- › NFC (Near Field Communication Scanner) for Tank Tag Use, Configurable on uPyxis®
- › 2.8 inch LCD Display and Button Interface
- › USB-C Charging Port
- › LoRa (Long Range Radio) Capable for Wireless Data Transfer
- › Consumptive Use Automatic with Each Level Reading



Item	PRL-100
Part Number	60388
Range	3.94-591 inches (0.1-15m)
Accuracy	±2mm
Dead Zone	3.94 inches (10cm)
Tag Scan Feature	NFC (Near Field Communication Scanner), Configurable to ANY Container via uPyxis®
Interface	Type-C for Charging & Data Transfer
Signal Output	Bluetooth® 5.0, Long Range Radio (LoRa)
Enclosure Rating	IP66
Installation	2 inch NPT Thread
Display	2.8 inch LCD Display
Regulation	CE/RoHS/UKCA



LSP-SERIES

Pressure Transducer Liquid Level Sensors.

Pressure-based submersible level sensors offered in 316L, PVC and PVDF transducer materials formatted for a variety of liquid level applications. Provides continuous liquid level measurement up to 393 inches with 4-20mA analog, RS-485 Modbus digital and Bluetooth® outputs.



DESCRIPTION

The LSP-100/200/300 devices offer a local display and can record up to 6 months of inventory data for wireless transfer via uPyxis® to email. The sensors can be powered by (4) AA Li/SOCl2 batteries or a 24VDC external power supply. These level sensors are ideally suited for applications where signal/power wiring may be difficult or unavailable. A 1.3in OLED display and four push-buttons are also included on the sensor for local display of level data and unit setup.

The LSP-101/201/301 devices use a 24VDC power supply only eliminating the battery compartment and local display/data storage, providing a 4–20mA output signal to any receiving device. This platform offers a lower cost alternative with superior accuracy and the convenience of rapid Bluetooth® configuration.

Item	LSP-100	LSP-200	LSP-300
Part Number	54005	54009	54010
Transducer Material	316L Stainless Steel	PVC	PVDF
Power Supply	(4) AA Batteries / 24VDC, 2W	(4) AA Batteries / 24VDC, 2W	(4) AA Batteries / 24VDC, 2W

Item	LSP-101	LSP-201	LSP-301
Part Number	54012	54013	54014
Transducer Material	316L Stainless Steel	PVC	PVDF
Power Supply	24VDC, 2W	24VDC, 2W	24VDC, 2W

CLOUD RADAR

Cloud-Based Radar Liquid Level Sensor.

An IoT Connected Radar Level Sensor (0–3m) that instantly sends data to the Pyxis Cloud Data Management System. Internal Lithium Battery allows for 5 Year Life Span with Cloud Access!



KEY FEATURES

- › 60GHz Radar
- › 0–3m Range (±0.5% Accuracy)
- › Multiband Modem supporting LTE-M & NB-IoT Networks
- › External Antenna
- › Internal Lithium Battery with 5 Year Life Span and 5 Year Cloud Access
- › Remote Configuration, Monitoring and Firmware Upgrades
- › Multiple Mounting and Installation Adapter Options

Item	Cloud Radar
Part Number	CLD-RADAR
Range	0–3m
Installation	2 inch MNPT Adapter, Wall Mounting Adapter, Place Directly on Plastic Containers
Configuration	Remotely via Pyxis Cloud Data Management Software
Communication	Multiband Modem supporting LTE-M/NB-IoT
Sensor Life Span	5 Years
Cloud Access	5 Years



ANALYZER SOLUTIONS

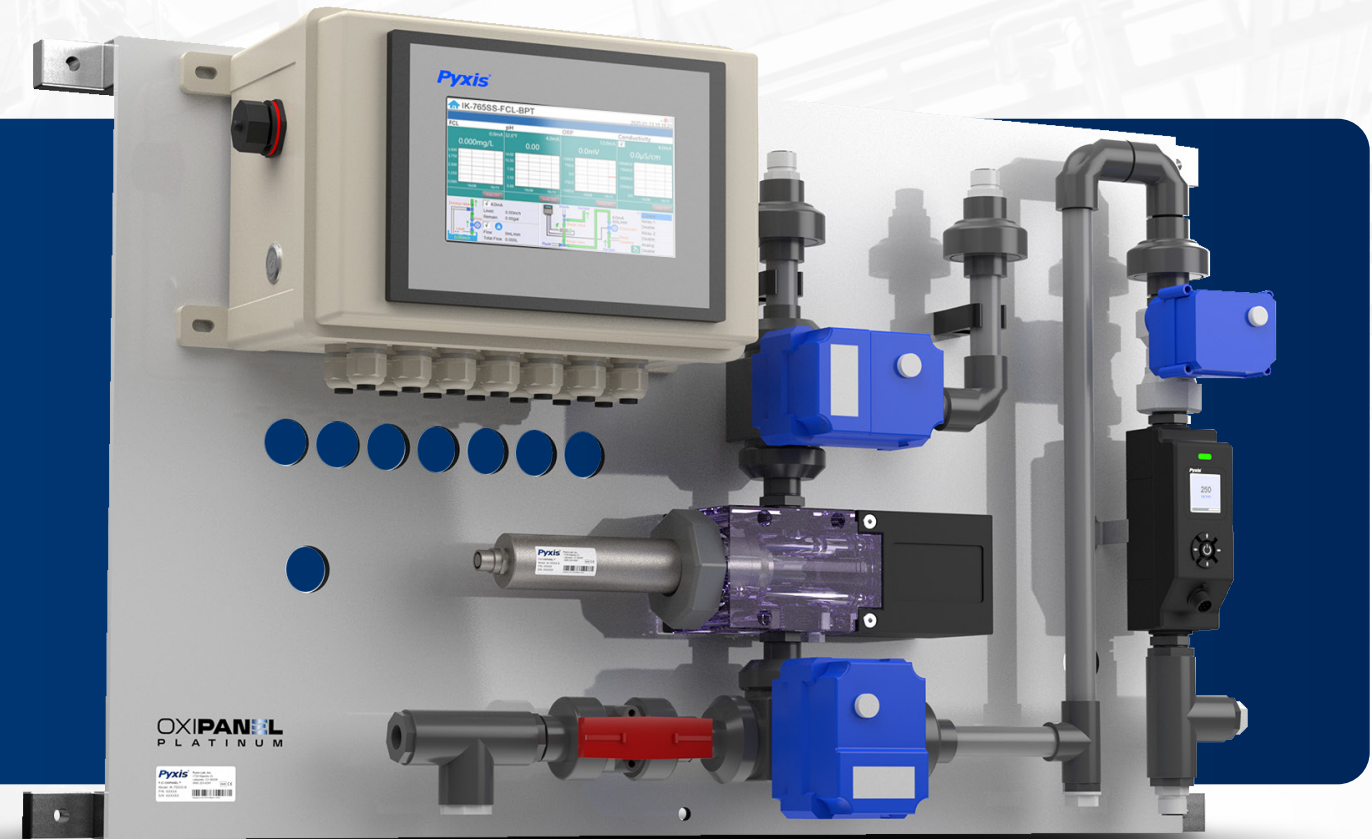

Pyxis Lab's panelized solutions deliver fully integrated, turnkey water monitoring and control systems designed for real-world operation. Featuring innovations like self-cleaning reservoirs, intuitive digital displays, and automated flow control, these systems simplify installation, reduce maintenance, and ensure consistent, reliable measurements—giving operators complete confidence in their data and process performance.



IK-765SS-BP SERIES

Auto-Brushing, Flow Control Oxidizer + pH + ORP Panel.

Challenging water demands smarter control. The OXIPANEL Plus IK-765-BP delivers rugged, membrane-free oxidizer measurement with automated cleaning and closed-loop flow control—so your data stays stable, accurate, and ready for action.

- F-Cl
- T-Cl
- ClO₂
- Br
- O₃
- NCL
- H₂O₂
- PAA
- SO₃
- DBNPA

OXIPANEL PLUS

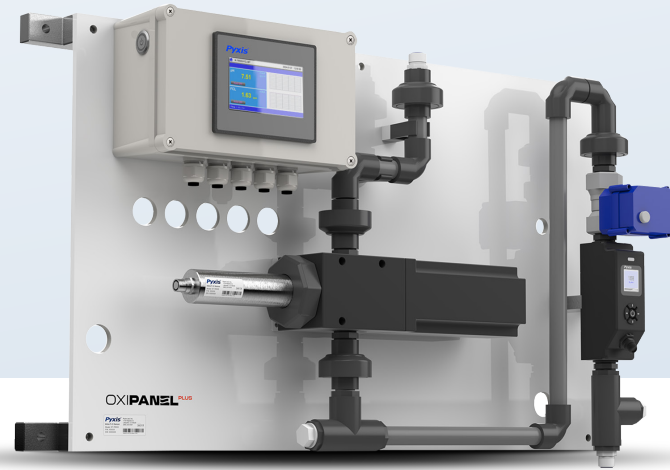

DESCRIPTION

OXIPANEL Plus IK-765-BP Series is a pre-mounted, inline turnkey analyzer built for challenging water applications. Featuring integrated ultrasonic flow control, the UC-80 color touchscreen/data-logger, and the FS-100 flowmeter with regulating valve, it delivers fast startup, clean installation, and stable process control across cooling water, food & industrial process water, raw water, and treated wastewater effluent.

Available in multiple oxidizer configurations — including Free & Total Chlorine, Bromine, Chlorine Dioxide, Hydrogen Peroxide, DBNPA, Ozone, and combination formats — the system simultaneously measures oxidant, pH, ORP, and temperature. At its core, the membrane-free ST-765SS smart sensor platform uses a bare-gold electrochemical design with automatic temperature and pH compensation for accurate, DPD-consistent readings (EPA-334.0 / ISO-7393 compliant).

With the FR-300-PLUS automated brush assembly and closed-loop FS-100 flow control, the OXIPANEL Plus maintains clean electrodes, stable signals, and longer maintenance intervals — delivering reliable, repeatable performance in the toughest water conditions.

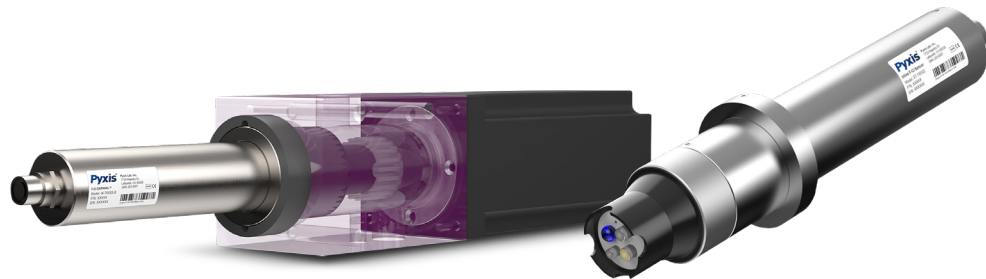

Item	Part Number	Species	Oxidizer Range
IK-765SS-TFCL-BP	46982	Total Chlorine + Free Chlorine + pH + Temp.	0.00–5.00ppm + 0.00–5.00ppm
IK-765SS-FCL-BP	41771	Free Chlorine + pH + ORP + Temp.	0.00–5.00ppm
IK-765SS-TCL-BP	47004	Total Chlorine + pH + ORP + Temp.	0.00–5.00ppm
IK-765SS-CLO-BP	44376	Chlorine Dioxide + pH + ORP + Temp.	0.00–5.00ppm
IK-765SS-Br-BP	48076	Bromine + pH + ORP + Temp.	0.00–5.00ppm
IK-765SS-H2O2-BP	47105	Hydrogen Peroxide + pH + ORP + Temp.	0–200ppm
IK-765SS-NCL-BP	49348	Monochloramine + pH + ORP + Temp.	0.00–5.00ppm
IK-765SS-PAA-BP	49511	Peroxyacetic Acid + pH + ORP + Temp.	0.00–100.00ppm
IK-765SS-O3	44923	Ozone + pH + ORP + Temp.	0.00–2.00ppm
IK-765SS-DCL-BP	48077	Free/Total Chlorine + Sulfite + pH + Temp.	0.00–5.00ppm + 0.00–100.00ppm

Item	IK-765SS-BP General Equipment Specifications
FS-100 Ultrasonic Flow Meter	
Method of Measurement	Ultrasonic Flow Detection
Rated Flow Range	0–3,000mL/min
Resolution/MAX Error	1mL/min or ±2% of Value
Display	1.44" Color 128x128 Resolution
Value Control Method	4-20mA from FS-100
FR-300 Plus Reservoir	
Suggest Flow Rate	200–800mL/min (User uses FS-100 to set this parameter)
Flow Interlock	Brush Motor Turns Off when in Auto-Mode if Flow <50mL/min and ON When >200mL/min
Rotational Speed	200RPM - Motorized Brush
UC-80 Display	
Display	4.3inch LCD Color 480x272 Pixel Resolution / Resistive Touch
Input	RS-485 Modbus - RTU
Output	(3) 4-20mA / RS-485 Modbus RTU / Modbus-TCP
Relay	(2) Relays (Passive Output or Active Output - User Selected)
Storage	Built-In 128MB of RAM of Storing up to 1-Million Data/Event Records
USB	(1) USB Host, for Data Downloading and Screen Upgrade
Relative Humidity	20–90% (No Condensation)
Altitude	<6,561ft (<2,000m)
PANEL	
Power Supply	96–260VAC / 50–60Hz; 60W USA Type-B Plug
Storage Temperature	-4–158 °F (-20–70 °C)
Dimensions	450mm H x 750mm W x 180mm D
Approximate Weight	~10kg
Wet Material	Polycarbonate / 304 Stainless Steel / Glass / Gold / Platinum / CPVC / PTFEPOM / PEEK / PET / NBR
Rating	IP-65 Panel & Display / IP-67 Sensors
Compliance	EPA-334.0 / ISO-7393
Regulation	CE Marked / RoHS / UKCA
Selectivity	Non-Selective, Cross Sensitive to Other Oxidizing Species
4G CloudLink™ Gateway	Included & Activated Upon Request with Enrollment - Contact Pyxis Lab, Inc. for Details



MFA-X00 SERIES

A Brand New Approach to Wet Chemistry Analyzers.

A new generation of pressurized, pump-free wet chemistry instrumentation designed to reduce maintenance, improve reliability and simplify online analysis.

- F-Cl
- T-Cl
- Orthophosphate
- Anionic Polymer
- Calcium Hardness



DESCRIPTION

The Titronex™ MFA-Series analyzers represent a new generation of pressurized, pump-free wet chemistry instrumentation designed to reduce maintenance, improve reliability, and simplify online analysis. The Titronex MFA Series integrates ultrasonic flow control, intelligent fluid handling, and sealed reagent cartridge technology into a compact turn-key platform. Unlike traditional analyzer architectures that depend on multiple peristaltic pumps and frequent tubing replacement, the Titronex MFA design operates directly from a pressurized water sample (up to approximately 72 psi depending on configuration), eliminating complex pump maintenance and reducing downtime.

Each injection-molded disposable reagent cartridge includes an integrated reagent dispersing mechanism. Reagent delivery is achieved using a hybrid gravity and chemical tube-roller distribution method — without the use of external metering pumps — improving reliability while minimizing operator service requirements. Once empty, cartridges are quickly replaced as a single sealed assembly. Cartridge life ranges from approximately 4,000 to 16,000 tests depending on model, chemistry, and measurement interval.

The Titronex MFA-600 analyzer is optimized for ultra-low hardness applications such as softener effluent, boiler feedwater, and RO feedwater monitoring. The Titronex MFA-100 Series measures free and total chlorine across cooling water, drinking water, food, beverage, industrial and commercial process systems. The Titronex MFA-310 provides stable orthophosphate monitoring for corrosion control and nutrient removal programs, while the MFA-400 focuses on anionic polymer monitoring (as PAA) in a wide variety of water treatment processes.

Designed with simplicity in mind, all wetted tubing is 316L stainless steel to enhance durability and chemical compatibility. Integrated relays provide alarm outputs for process integration, and operators may configure the system to run in constant-flow-to-drain mode or water-saving mode, which prevents continuous discharge during non-sampling periods, both with Flow-Interlock protection. Integrated NB-IoT / 4G connectivity, Modbus RS-485, and dual 4–20 mA outputs allow seamless integration with SCADA, PLC, DCS or remote cloud monitoring platforms.

Compared to conventional analyzer designs often found in the market, the Titronex MFA Series focuses on reduced maintenance, stable flow control, simplified operation, and improved long-term reliability.



Item	MFA-600	MFA-100	MFA-110	MFA-310	MFA-400
Part Number	41748	40196	43485	45224	45477
Target Analyte	Calcium Hardness	Free Chlorine	Total Chlorine	Orthophosphate	Anionic Polymer
Range	0–5ppm Ca as CaCO ₃	0–5ppm as CL ₂		0–25ppm as PO ₄	0–20ppm as PAA
Measurement Method	Chlorophosphonazo III	DPD Colorimetric Method (N, N Diethyl-1,4 Phenylenediamine)		Molybdovanadate (Yellow) Method	Turbidimetric Method
Reagent Required	Hardness-600	FCL-100	TCL-100	Phosphate-310	Polymer-400
Reagent Part Number	37109	36421	35700	31719	30545
Reagent Shelf Life	12 Months	6 Months	6 Months	12 Months	12 Months
Measurement Capacity	up to 4,000 Tests	up to 16,000 Tests	up to 16,000 Tests	up to 8,000 Tests	up to 16,000 Tests

Item	IK-765SS-BP General Equipment Specifications
Measurement Interval	Selectable: 1min, 2min, 5min, 10min, up to 360min - Configurable via the Controller Menu
Sample Inlet Pressure	7.25–72.5psi (0.05–0.5MPa)
Sample Inlet Flow Range	100–500mL/min
Sample Inlet/Outlet	¼ inch Tube Fitting
Sample Waste Outlet	¼ inch Tube Fitting
FS-100 Ultrasonic Flow Meters and Control Valves	
Range of Measurement	0–3,000mL/min
Resolution / Accuracy	1mL/min / 10mL or ±1% of the value, whichever is greater
Operation Mode	Operates in Flow Control (C) Mode, Recommended Control Flow Rate Range is 100–500mL/min
UC-60 Display	
Display	4.3inch LCD Color Touchscreen
Analog Outputs	(2) 4-20mA Current Outputs
Digital Outputs	(1) Isolated RS-485, Modbus RTU
Relay Output	(2) SPST Relays (Dry Contact) / Contact Rating: 5A 250VAC/30VDC
Power Supply	100–240VAC, 50/60Hz
USB Interface	For Data Downloading and Firmware Upgrade
Humidity	5–95% No Condensation
Protection	IP-65
4G CloudLink™	Included and Activated upon request with enrollment - Contact Pyxis Lab, Inc. for Details
PANEL	
Operating Temperature	32–122 °F (0–50 °C)
Storage Temperature	-4–158 °F (-20–70 °C)
Dimensions	144mm H x 144mm W x 120mm D





IK-766SS-BPT SERIES

Auto-Brushing, Self-Cleaning Oxidizer + pH + ORP Panel.

When water gets aggressive, your analyzer can't afford to flinch. The OXIPANEL Platinum IK-766-BPT is built to stay clean, stay stable, and stay accurate—no matter how dirty the process gets.

- F-Cl
- T-Cl
- ClO₂
- Br
- NCL
- PAA
- SO₃

OXIPANEL PLATINUM



DESCRIPTION

The OXIPANEL Platinum IK-766-BPT series is a pre-mounted, in-line, multi-parameter analyzer built for the toughest water. Each panel integrates a mechanical brushing reservoir, ultrasonic flow control, auto fresh-water flush, and detergent feed relays, delivering a true Turn-Key monitoring solution for cooling water, food and industrial process water, raw water, and treated wastewater effluent. Every system is provided pre-plumbed and factory-configured for rapid startup and consistent performance including the Pyxis UC-80-PLUS color touch display/data-logging terminal plus the Pyxis FS-100 ultrasonic flowmeter with regulating valve.

At its core, the OXIPANEL Platinum uses ST-766SS-Series smart sensors to provide highly accurate, repeatable, real-time measurement of multiple oxidizer species and pH, ORP, conductivity, and temperature, with automatic temperature and pH compensation to keep readings on-spec under real operating conditions. The IK-766-BPT platform is available in eight sensor formats to match your chemistry: Free Chlorine (FCL), Total Chlorine (TCL), Free + Total Chlorine (TFCL), Bromine (Br), Chlorine Dioxide (ClO₂), Monochloramine (NCL), Peracetic Acid (PAA), and Chlorine + Sulfite (DCL).

For contaminated and variable streams, the OxiPanel-PLATINUM adds a fresh-water flush line input with a 3-way motorized valve for user-programmed auto-flush, 110VAC detergent feed relays, and the FR-306-PLUS clear-chamber mechanical brush flow assembly to maintain optimum sensor electrode cleanliness in waters laden with food byproduct, oil, line-lube, grease, paper fines, and other foulants. The rugged flow-path design and self-cleaning/anti-fouling features keep sensors free of fouling, delivering stable measurements, longer maintenance intervals, and minimal downtime where conventional membrane amperometric or wet-chemistry analyzers quickly fail.

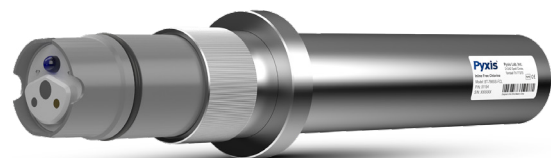

Item	Part Number	Species	Oxidizer Range
IK-766SS-TFCL-BPT	42270	Total Chlorine + Free Chlorine + pH + Temp.	0.00–5.00ppm + 0.00–5.00ppm
IK-766SS-FCL-BPT	48751	Free Chlorine + pH + ORP + Temp.	0.00–5.00ppm
IK-766SS-TCL-BPT	46990	Total Chlorine + pH + ORP + Temp.	0.00–5.00ppm
IK-766SS-ClO-BPT	48512	Chlorine Dioxide + pH + ORP + Temp.	0.00–5.00ppm
IK-766SS-Br-BPT	47939	Bromine + pH + ORP + Temp.	0.00–5.00ppm
IK-766SS-NCL-BPT	46117	Monochloramine + pH + ORP + Temp.	0.00–5.00ppm
IK-766SS-PAA-BPT	48150	Peroxyacetic Acid + pH + ORP + Temp.	0.00–100.00ppm
IK-766SS-DCL-BPT	40759	Free/Total Chlorine + Sulfite + pH + Temp.	0.00–5.00ppm + 0.00–100.00ppm

Item	Titronex™ MFA-Series General Specifications
FS-100 Ultrasonic Flow Meter	
Method of Measurement	Ultrasonic Flow Detection
Rated Flow Range	0–3,000mL/min
Resolution/MAX Error	1mL/min or ±2% of Value
Display	1.44" Color 128x128 Resolution
Value Control Method	4-20mA from FS-100
FR-306 Plus Reservoir	
Suggest Flow Rate	200–800mL/min (User uses FS-100 to set this parameter)
Flow Interlock	Brush Motor Turns Off when in Auto-Mode if Flow <50mL/min and ON When >200mL/min
Rotational Speed	200RPM - Motorized Brush
UC-80 PLUS Display	
Display	7inch LCD Color Resistive Touch
Input	(2) 4-20mA / RS-485 Modbus-RTU
Output	(5) 4-20mA / RS-485 Modbus-RTU / Modbus-TCP
Relay	(2) VAC Relays / (1) 24VDC Relay (Passive or Active - User Selected) / (1) Analog PID Output
Storage	Built-In 128MB of RAM for Storing up to 1-Million Data/Event Records
USB	Built-In 128MB of RAM for Storing up to 1-Million Data/Event Records
Relative Humidity	20–90% (No Condensation)
Altitude	<6,561ft (<2,000m)
PANEL	
Power Supply	96–260VAC / 50–60Hz; 60W USA Type-B Plug
Storage Temperature	-4–158 °F (-20–70 °C)
Dimensions	500mm H x 800mm W x 230mm D / ~20kg
Wet Material	Polycarbonate / 304SS / 316SS / Glass / Gold / Platinum / CPVC / PTFEPOM / ABS / PEEK / PET / NBR
Rating	IP-65 Panel & Display / IP-67 Sensors
Regulation	CE Marked / RoHS / UKCA
Selectivity	Non-Selective, Cross Sensitive to Other Oxidizing Species
4G CloudLink™ Gateway	Included & Activated Upon Request with Enrollment - Contact Pyxis Lab, Inc. for Details



KRYOPTIX™ IK-1500 SERIES

Modular CDU Coolant Analyzers.

The IK-1500 Series are panelized, multiparameter coolant monitoring modules for AI-Critical CDU applications. Integrating Glycol concentration, pH, Conductivity, Turbidity and temperature measurement into a single stainless steel platform.

- nD
- %PG25
- NTU
- pH
- μS/cm



KEY FEATURES

- › ST-710SS pH Sensor with Replaceable Electrode Head Assembly
- › ST-722 Ultra-Low Conductivity Sensor
- › ST-730SS-T Tee Ready Stainless Steel Turbidity Sensor
- › RT-100 (with Local Display) or RT-110L PRISM Inline Refractometer
- › Native 4-20mA and RS-485 Modbus RTU/TCP Outputs
- › Factory Assembled, Calibrated and Pre-Configured for Simple Installation and Performance

Item	IK-1500	IK-1500A
Part Number	41438	41179
Glycol Sensor	RT-100	RT-110L for Smaller Footprint
Refractive Index / Glycol Range	1.31700–1.5100 ±0.0001 / 0.00–100.00% ±0.1% (MEG, MPG, PG25)	
pH Range	0.00–14.00 ±0.01pH	
Turbidity Range	0.00–100.00NTU ±0.1NTU	
Conductivity Range	0.02–10,000μS/cm ±0.2μS/cm	
Sample Operating Temp.	4–49 °C (40–120 °F)	
Sample MAX Pressure	100psi (6.9Bar)	
Inlet/Outlet Size	¼ inch OD Swagelok Compression	
Suggested Flow Rate	100–2,000mL/min	
Display	N/A	



KRYOPTIX™ IK-1600 SERIES

Panelized CDU Coolant Analyzer.

The IK-1600 Series are pre-engineered, turn-key fluid chemistry analyzers designed specifically for data center Coolant Distribution Units (CDUs). Built on a stainless steel panel and factory integrated Pyxis smart sensors and touch screen interface.

- nD
- %PG25
- NTU
- pH
- μS/cm



KEY FEATURES

- › ST-710SS pH Sensor with Replaceable Electrode Head Assembly
- › ST-722 Ultra-Low Conductivity Sensor
- › ST-730SS-T Tee Ready Stainless Steel Turbidity Sensor
- › RT-100 (with Local Display) or RT-110L PRISM Inline Refractometer
- › Native 4-20mA and RS-485 Modbus RTU/TCP Outputs
- › Factory Assembled, Calibrated and Pre-Configured for Simple Installation and Performance
- › UC-80 PLUS Touchscreen Display and Data Logging Terminal

Item	IK-1600	IK-1600A
Part Number	41438	41179
Glycol Sensor	RT-100	RT-110L for Smaller Footprint
Refractive Index / Glycol Range	1.31700–1.5100 ±0.0001 / 0.00–100.00% ±0.1% (MEG, MPG, PG25)	
pH Range	0.00–14.00 ±0.01pH	
Turbidity Range	0.00–100.00NTU ±0.1NTU	
Conductivity Range	0.02–10,000μS/cm ±0.2μS/cm	
Sample Operating Temp.	4–49 °C (40–120 °F)	
Sample MAX Pressure	100psi (6.9Bar)	
Inlet/Outlet Size	¼ inch OD Swagelok Compression	
Suggested Flow Rate	100–2,000mL/min	
Display	UC-80 PLUS Display & Data Logging Terminal with 7 inch LCD Color Industrial Touchscreen	





IK-765P-DCL

Reverse Osmosis Dechlorination Analyzer.

Protect membranes and critical water systems with continuous, high-accuracy monitoring of chlorine and sulfite residuals. The IK-765P-DCL provides simultaneous multi-parameter measurement in a compact, ready-to-install panel solution.

- F-Cl
- SO₃
- PTSA



DESCRIPTION

The IK-765P-DCL is a turnkey, multi-parameter inline analyzer for continuous monitoring of chlorine removal and membrane protection applications. Using proprietary membrane-free ST-765P smart sensor technology, it simultaneously measures Free or Total Chlorine (user-selectable), Sulfite Residual, pH, and Temperature, with real-time display and data logging via the UC-80 touchscreen terminal. Constructed of CPVC for fresh water and seawater applications, the system enables quick installation and simplified maintenance. An integrated FS-100 ultrasonic flow sensor with motorized ball valve provides precise sample flow control and measurement accuracy, while optional ST-500RO PTSA integration supports monitoring of traced antiscalant treatment programs.

Item	IK-765P-DCL
Part Number	49514
Chlorine Range	0.001-5.000mg/L (User Selects Free or Total Chlorine)
Sulfite Range	0.001-100.00mg/L
pH Range	0-14
PTSA Range (Optional)	0.00-40.00ppb
Operational Temperature	4-49 °C (40-120 °F)
Inlet Pressure	7.25-60psi (0.05-0.4MPa)
Suggested Flow Rate	200-800mL/min
Inlet/Outlet Size	½ inch NPT
Display	UC-80 4.3inch LCD Color Touchscreen Display
Display Outputs	(3) 4-20 mA / RS-485 Modbus-RTU / Modbus-TCP



IK-765SS SERIES

Drinking/Clean Water Oxidizer + pH Analyzers.

Real-time, accurate measurement of oxidant level and pH for clean water applications. Utilizing the ST-765SS Series membrane-free, bare-gold electrochemical oxidizer detection, the IK-765SS Series offers minimal maintenance and high performance.

- F-Cl
- NCL
- ClO₂

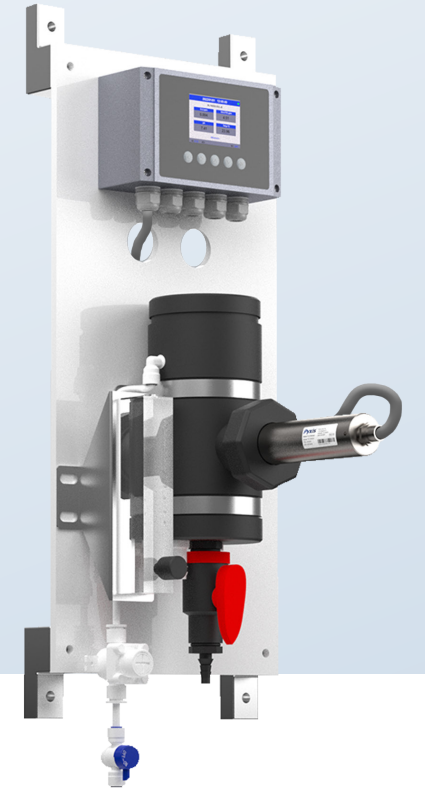

DESCRIPTION

The IK-765 Series are inline water analyzers specifically designed as a 'Turn-Key' monitoring solution for clean water applications including drinking water networks, secondary water supply and decorative/swimming water applications. The IK-765 Series offers highly accurate, real-time measurement, display and data logging of an oxidizer, pH and temperature utilizing our ST-765SS Series sensors and UC-50 micro-display.

The IK-765SS Series are offered in three formats for Free Chlorine, Chlorine Dioxide and Monochloramine depending on the desired oxidant being measured.

Item	IK-765SS-FCL	IK-765SS-CLO	IK-765SS-NCL
Part Number	42082	42085	42161
Oxidizer Range	0.00-5.00ppm (Free Chlorine)	0.00-5.00ppm (Chlorine Dioxide)	0.00-5.00ppm (Monochloramine)
pH Range	0-14		
Sensor Housing	FR-50 Flow Reservoir		
Operational Temperature	4-40 °C (40-104 °F)		
Inlet Pressure	7.25-30psi		
Suggested Flow Rate	600-1,800mL/min		
Inlet/Outlet Size	½ inch NPT		
Display	UC-50 2.8inch Color Display with Button Interface		
Display Outputs	(1) 4-20mA / RS-485 Modbus RTU / (1) Contact Relay		
Compliance	EPA-334.0 / ISO-7393		





DW-739

Drinking/Clean Water Turbidity Analyzer.

A single parameter inline turbidity analyzer designed as a turn-key Turbidity monitoring solution for clean water applications. Offering accurate, real-time measurement and display of Ultra-Low Turbidity.

NTU



KEY FEATURES

- › LT-739/B Ultra-Low Resolution Turbidity Sensor with 90° Surface Scatter Format
- › FR-100 Single Sensor Flow Reservoir for Dissipation of Air Bubbles
- › UC-100 Touchscreen Display and Data Logging Interface
- › Convenient and Simple to Install Back Panel for Rapid Installation
- › For NSF Certified Applications, Discharge Flow 200–400mL/min may be sent to Sanitary Drain or Returned to the Inlet of the Pretreatment System

Item	DW-739	DW-739B
Part Number	42143	42144
Turbidity Range	0.01–10 / 10–40.00NTU ±0.005NTU	0.01–10 / 10–40.00NTU ±0.005NTU
Light Source / Compliance	Warm White LED / EPA-180.1, EPA-334.0	860nm LED InfraRed / ISO-7027, ISO-7393
Measurement Interval	Continuous	
Response Time	4s After Immersion - Turbidity, T95≤60s	
Operational Temperature	40–113 °F (4–45 °C)	
Sample Water Pressure	7.25–30psi (0.05–0.2MPa)	
FR-100 Flow Rate	200–400mL/min	
FR-100 Line Size	¼ inch Inlet, ¾ inch Overflow, 20mm Outlet, ½ inch Drain	
Display	UC-100 7 inch LCD Color Industrial Touchscreen Display & Data Logging Terminal	
Display Outputs	(2) 4–20 mA / RS-485 Modbus-RTU / Modbus-TCP	



DW-2100P

Drinking/Clean Water Oxidizer + pH + Turbidity.

A multiparameter inline turbidity, free chlorine and pH analyzer designed as a turn-key Turbidity monitoring solution for clean water applications.

F-Cl

NTU

pH



KEY FEATURES

- › LT-739/B Ultra-Low Resolution Turbidity Sensor with 90° Surface Scatter Format
- › ST-765SS Free Chlorine + pH + Temperature Sensor with Replaceable Electrode Head
- › FR-200 Dual Sensor Flow Reservoir for Dissipation of Air Bubbles
- › UC-100 Touchscreen Display and Data Logging Interface
- › Convenient and Simple to Install Back Panel for Rapid Installation

Item	DW-2100P-US	DW-2100P-EU
Part Number	42135	42136
Light Source / Compliance	Warm White LED / EPA-180.1, EPA-334.0	860nm LED InfraRed / ISO-7027, ISO-7393
Chlorine Range	0.001–5.000mg/L (User Selects Free or Total Chlorine)	
Turbidity Range	0.001–10 / 10–40.00NTU	
pH Range	0–14	
Operational Temperature	40–113 °F (4–45 °C)	
Sample Water Pressure	7.25–30psi (0.05–0.2MPa)	
FR-200 Flow Rate	600–1,000mL/min	
FR-200 Line Size	¼ inch Inlet, ¾ inch Overflow, 20mm Outlet, ½ inch Drain	
Display	UC-100 7 inch LCD Color Industrial Touchscreen Display & Data Logging Terminal	
Display Outputs	(3) 4–20 mA / RS-485 Modbus-RTU / Modbus-TCP	





IK-73X PLUS

Self-Brushing Turbidity Analyzers.

The IK-73X Plus Analyzers offer accurate Ultra-Low Turbidity measurement with an integrated FT-100 Plus auto-brushing flow reservoir for continuous cleaning of the sensor head.

NTU

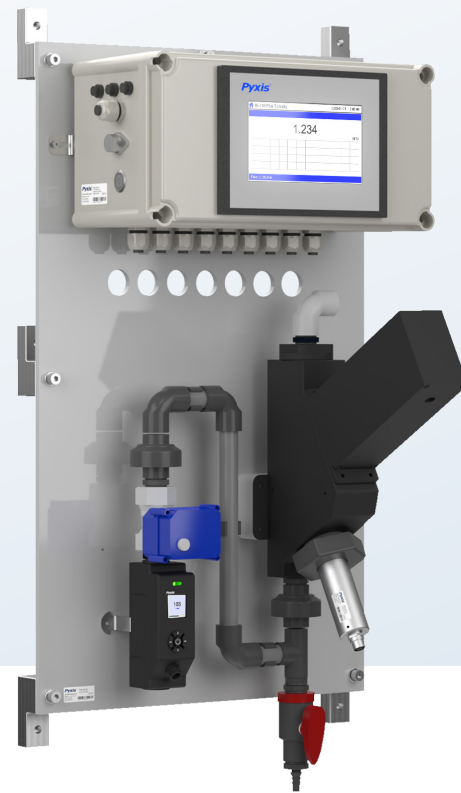

KEY FEATURES

- › LT-73X Ultra-Low Resolution Turbidity Sensor with 90° Surface Scatter Format
- › FR-100 Plus Automated Brushing Reservoir for Simple Maintenance
- › FS-100 Ultrasonic Flow Meter with Control Valve for User Defined Flow Rate
- › UC-100 Touchscreen Display and Data Logging Interface
- › Convenient and Simple to Install Back Panel for Rapid Installation

Item	IK-736 PLUS	IK-739PLUS
Part Number	12003	12001
Turbidity Range	0.00-40.00NTU	0.00-1,000NTU
Light Source	Warm White LED	
Compliance	EPA-180.1	
Measurement Interval	Continuous	
Sample Temperature	Instrument: -4-131 °F (-20-55 °C) / Sensor: 32-122 °F (0-50 °C)	
Sample Pressure	7.25-100psi (0.05-0.67MPa)	
Sample Flow Rate	500-2,000mL/min	
Sample Line Size	½ inch NPT	
Display	UC-100 7 inch LCD Color Industrial Touchscreen Display & Data Logging Terminal	
Display Outputs	(2) 4-20 mA / RS-485 Modbus-RTU / Modbus-TCP	



WQMS-2000 SERIES

Bottled & Beverage Water Multiparameter Analyzer.

Multiparameter inline water analyzers designed as turn-key water quality monitoring solutions for bottled water and beverage production applications. Offering real-time measurement and display of Ultra-Low Turbidity, Ozone, Conductivity/TDS, pH and Temperature.

O3

NTU

pH

µS/cm

TDS

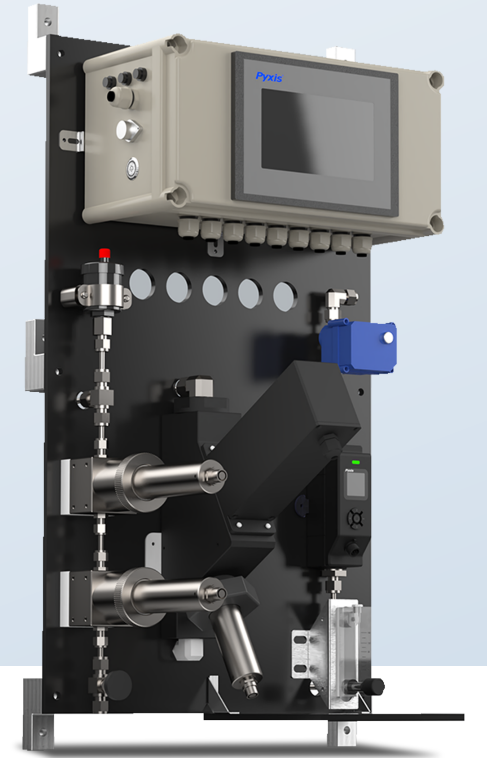

KEY FEATURES

- › LT-739/B Ultra-Low Resolution Turbidity Sensor with 90° Surface Scatter Format
- › ST-765SS-O3 Ozone + pH + Temperature Sensor with Replaceable Electrode Head
- › ST-724 Ultra-Low Conductivity Sensor
- › UC-100 Touchscreen Display and Data Logging Interface
- › Convenient and Simple to Install Back Panel for Rapid Installation

Item	WQMS-2000	WQMS-2100
Part Number	41396	46817
Brushing Turbidity Flow Cell	Included	N/A
Ozone Range	0.01-2.00ppm as O3	
Turbidity Range	0.001-10 / 10-40.00NTU	
pH Range	0-14	
TDS/Conductivity Range	0.02-1,000µS/cm	
Sample Water Pressure	7.25-30psi (0.05-0.2MPa)	
Sample Water Flow Rate	100-300mL/min	
Sample Water Temperature	40-120 °F (4-49 °C)	
Display	UC-100 7 inch LCD Color Industrial Touchscreen Display & Data Logging Terminal	
Display Outputs	(5) 4-20 mA / RS-485 Modbus-RTU / Modbus-TCP	





WQMS-2300

Dual Sample Water Quality Analyzer.

Dual-Sample multiparameter inline water analyzer designed as a turn-key solution for clean water applications including Spring & Reverse Osmosis drinking water, beverage manufacturing and primary/secondary water supply networks.

- O3
- NTU
- pH
- µS/cm
- TDS

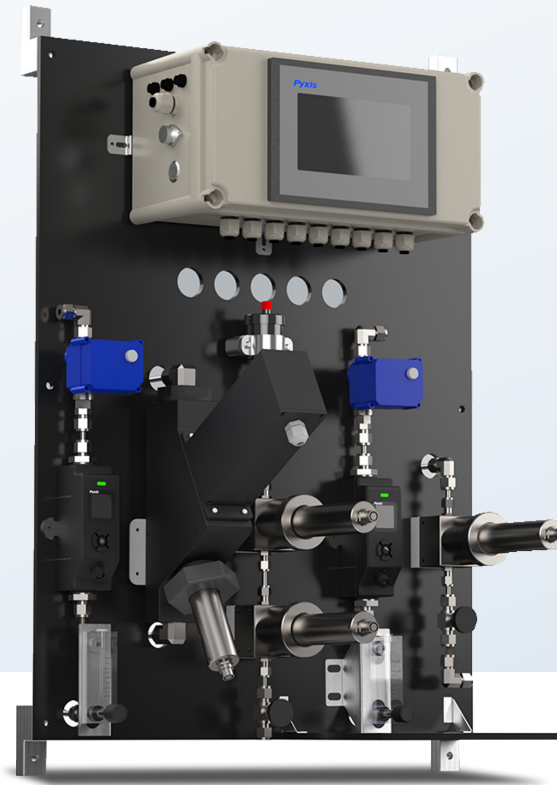

KEY FEATURES

- › LT-739/B Ultra-Low Resolution Turbidity Sensor with 90° Surface Scatter Format
- › ST-765SS-O3 Ozone + pH + Temperature Sensor with Replaceable Electrode Head
- › ST-724 Ultra-Low Conductivity Sensor
- › UC-100 Touchscreen Display and Data Logging Interface
- › Convenient and Simple to Install Back Panel for Rapid Installation

Item	WQMS-2300
Part Number	49472
Turbidity Light Source	Warm White LED
Turbidity Range	0.001-10 / 10-40.00NTU
Ozone Range	0.01-2.00ppm as O3
pH Range	0.00-14.00pH
TDS/Conductivity Range	0.02-1,000µS/cm
Sample Water Pressure	7.25-30psi (0.05-0.2MPa)
Sample Water Flow Rate	100-300mL/min
Sample Water Temperature	40-140 °F (4-40 °C)
Display	UC-100 7 inch LCD Color Industrial Touchscreen Display & Data Logging Terminal
Display Outputs	(6) 4-20 mA / RS-485 Modbus-RTU / Modbus-TCP



WQMS-2500

Bottled & Beverage Water Quality Analyzer.

Multiparameter inline water analyzers designed as turn-key water quality monitoring solutions for bottled water and beverage production applications. Offering real-time measurement and display of Ultra-Low Turbidity, Ozone, Conductivity/ TDS, pH and Temperature.

- F-CL
- NTU
- pH
- µS/cm
- TDS

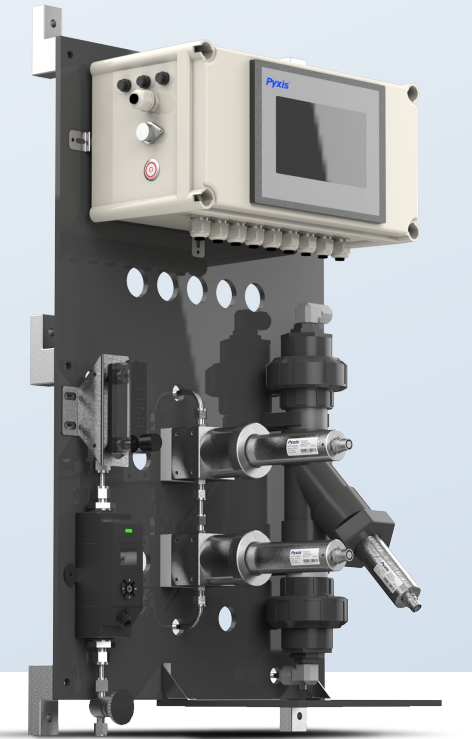

KEY FEATURES

- › LT-739/B Ultra-Low Resolution Turbidity Sensor with 90° Surface Scatter Format
- › ST-765SS-FCL Free Chlorine + pH + Temperature Sensor with Replaceable Electrode Head
- › ST-724 Ultra-Low Conductivity Sensor
- › UC-100 Touchscreen Display and Data Logging Interface
- › Convenient and Simple to Install Back Panel for Rapid Installation

Item	WQMS-2500-US	WQMS-2500-EU
Part Number	49726	43930
Light Source / Compliance	Warm White LED / EPA-180.1, EPA-334.0	860nm LED InfraRed / ISO-7027, ISO-7393
Turbidity Range	0.001-10 / 10-40.00NTU	
Chlorine Range	0.001-5.00ppm Free Residual Chlorine	
pH Range	0-14	
TDS/Conductivity Range	0.02-1,000µS/cm	
Sample Water Pressure	7.25-30psi (0.05-0.2MPa)	
Sample Water Flow Rate	100-300mL/min	
Sample Water Temperature	40-120 °F (4-49 °C)	
Display	UC-100 7 inch LCD Color Industrial Touchscreen Display & Data Logging Terminal	
Display Outputs	(5) 4-20 mA / RS-485 Modbus-RTU / Modbus-TCP	





IK-765SS-O3

Ozone + pH Analyzer for Bottled & Beverage Water.

Dual parameter inline water analyzer designed as a turn-key monitoring solution for clean water applications. Offering accurate, real-time measurement of Ozone, pH and Temperature coupled with the UC-80 Display & Data Logging Terminal.

- pH
- O3
- Temperature



KEY FEATURES

- › ST-765SS-O3 Ozone + pH + Temperature Sensor with Replaceable Electrode Head
- › FS-100 Ultrasonic Flow Meter
- › UC-80 Touchscreen Display and Data Logging Interface
- › Convenient and Simple to Install Back Panel for Rapid Installation

Item	IK-765SS-O3
Part Number	42091
Ozone Range	0.01–2.00ppm
Ozone Precision	±0.1mg/L or 1% of the value with pH Compensation up to 9.0+
pH Range	0–14
pH Precision	±0.01pH
Operational Temperature	4–40 °C (40–104 °F)
Inlet Pressure / MAX Pressure	7.25–30psi (0.05–0.2MPa) / 100psi (6.9Bar)
Suggested Flow Rate	100–300mL/min
Inlet/Outlet Size	¼ inch OD
Display	UC-80 4.3inch LCD Color Touchscreen Display
Display Outputs	(2) 4-20 mA / RS-485 Modbus-RTU / Modbus-TCP



ST-774 PORTAPANEL

Portable Panel for Dissolved Oxygen.

Prefabricated panel suited for portable oxygen measurement using the ST-774 Ultra-Low Dissolved Oxygen Sensor and UC-50 local display & data logging terminal.

- Dissolved Oxygen



KEY FEATURES

- › Ideal for Dissolved Oxygen Studies
- › Portable, Free Standing Panel made of 316L Stainless Steel
- › Fully Integrated Plumbing and Flow Cell
- › 0.4–2,000µg/L Measurement Range
- › Built-In Temperature and Pressure Sensors
- › Pre-Mounted UC-50 Display & Data Logging Terminal
- › Direct RS-485 Modbus Connection to the UC-50

Item	ST-774 PortaPanel
Part Number	53715
Dissolved Oxygen Range	0.0–2,000µg/L (ppb)
Lower Level Detection	0.1µg/L (ppb)
Light Source	Blue Light Irradiated Excitation / Red Light Reference
Accuracy	±0.3µg/L (ppb) or 1% whichever is greater
Operational Temperature	0–50 °C (32–122 °F)
Operating Pressure	145psi (10Bar)
Suggested Flow Rate	50–500mL/min
Installation	¼ inch OD Swagelok
Display	UC-50 Micro Display and Data Logging Terminal
Display Outputs	4-20mA and RS-485 Modbus





IK-2000 SERIES

Boiler Feedwater Multiparameter Analyzer.

The IK-2000 Series are multiparameter water quality analyzers designed as a turn-key monitoring solution for boiler feedwater and chemical treatment applications.

pH
SO₃
Fluorescein
SCAN
Dissolved Oxygen
µS/cm



DESCRIPTION

With all sensor options installed, the Guardian boiler feedwater series offers highly accurate and repeatable, real-time measurement, display, and data-logging of sample water Dissolved Oxygen (ppb), Temperature (°C/°F), pH, ORP (mV), Sulfite (ppm), Conductivity (µS/cm), Total Dissolved Solids (ppm) and Sample Flow Rate (mL/Min) utilizing proprietary Pyxis Lab smart sensor technology coupled with a color touch screen display and data logging terminal. The Guardian boiler feedwater series should always be installed downstream of a sample cooler and are offered in a convenient and easy to integrate panel mounted format using only 304 and 316L stainless steel with SwageLok™ compression fittings to ensure optimum sensor performance and longevity. With an integrated shelf for easy sensor calibration and maintenance, the Guardian Boiler Feedwater Series was designed with the user in mind. The Guardian IK-2000 series boiler feedwater analyzer integrates up to four (4) unique Pyxis smart sensors.

Item	IK-2000	IK-2010	IK-2020	IK-2030
Part Number	47522	47744	43809	48807
ST-774 Dissolved Oxygen	Included	Included	Included	Included
ST-765-SO3 Sulfite + pH	Add Later If Desired	Included	Included	Included
ST-525SS-T Fluorescein	Add Later If Desired	Add Later If Desired	Included	Included
ST-724 Conductivity	Add Later If Desired	Add Later If Desired	Add Later If Desired	Included

Item	General Specifications
Dissolved Oxygen Range	0.1-2,000ppb
Sulfite Range	0.00-100.00ppb
Fluorescein Range	0.00-60.00ppb
Conductivity Range	0.02-1,000µS/cm
Display	UC-100AGS 7inch LCD Color Touchscreen Display & Data Logging Terminal
Outputs	(6) 4-20mA, RS-485 Modbus-RTU, Modbus-TCP

IK-2000 PRO SERIES

Boiler Feedwater Analyzer for Controller Integration.

The IK-2000-PRO multiparameter analyzer for boiler feedwater and chemical treatment applications offers the same sensors and panel layout with the PowerPack-5 PRO, enabling users to mount and wire any OEM controller to the panel.

pH
SO₃
Fluorescein
SCAN
Dissolved Oxygen
µS/cm

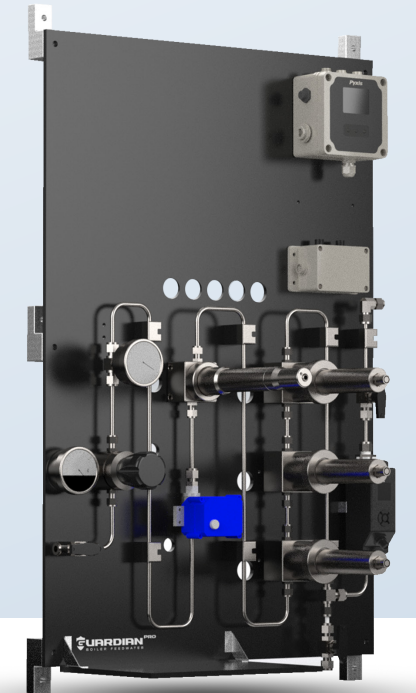

DESCRIPTION

With all sensor options installed, the Guardian boiler feedwater series offers highly accurate and repeatable, real-time measurement, display, and data-logging of sample water Dissolved Oxygen (ppb), Temperature (°C/°F), pH, ORP (mV), Sulfite (ppm), Conductivity (µS/cm), Total Dissolved Solids (ppm) and Sample Flow Rate (mL/Min) utilizing proprietary Pyxis Lab smart sensor technology coupled with a color touch screen display and data logging terminal. The Guardian boiler feedwater series should always be installed downstream of a sample cooler and are offered in a convenient and easy to integrate panel mounted format using only 304 and 316L stainless steel with SwageLok™ compression fittings to ensure optimum sensor performance and longevity. With an integrated shelf for easy sensor calibration and maintenance, the Guardian Boiler Feedwater Series was designed with the user in mind. The Guardian IK-2000 series boiler feedwater analyzer integrates up to four (4) unique Pyxis smart sensors.

Item	IK-2000-PRO	IK-2010-PRO	IK-2020-PRO	IK-2030-PRO
Part Number	45050	48852	41319	45232
ST-774 Dissolved Oxygen	Included	Included	Included	Included
ST-765-SO3 Sulfite + pH	Add Later If Desired	Included	Included	Included
ST-525SS-T Fluorescein	Add Later If Desired	Add Later If Desired	Included	Included
ST-724 Conductivity	Add Later If Desired	Add Later If Desired	Add Later If Desired	Included

Item	General Specifications
Dissolved Oxygen Range	0.1-2,000ppb
Sulfite Range	0.00-100.00ppb
Fluorescein Range	0.00-60.00ppb
Conductivity Range	0.02-1,000µS/cm
Display	PowerPACK-5 PRO Power and Bluetooth® 5.0 Auxiliary Adapters
Signal Output Adapter	(up to 10x) 4-20mA and RS-485 Modbus



ADAPTERS & ACCESSORIES

Pyxis Lab's communication adapters and displays provide flexible connectivity options for both local and remote operation. Whether enabling Bluetooth[®] access for on-site configuration, calibration, and monitoring via the uPyxis[®] app, or transmitting data to cloud-based platforms for remote visibility, these solutions simplify integration and give operators complete control over their systems.





POWERPACK SERIES

Bluetooth® + Power Auxiliary Adapters.

Bluetooth® Auxiliary Adapters uniquely designed to provide additional power budget and wireless communication to drive Pyxis sensors to a receiving microprocessor controller, PLC or DCS with limited power supply.



KEY FEATURES

- › Power Supply and Connection (up to 4) Pyxis Lab® Sensors
- › 4-20mA Signal Output of (up to 4) Pyxis Lab® Sensors to any Controller
- › RS-485 Signal Passthrough also provided in PowerPACK-2 and PowerPACK-4
- › Bluetooth® Version 5.0 for Wireless Sensor Diagnosis, Calibration & Configuration via uPyxis®
- › Broad Range External Power Input (100–240VAC)
- › ABS Enclosure with IP-54 Protection



Item	PowerPACK-1	PowerPACK-2	PowerPACK-4
Part Number	MA-BLE-1	MA-BLE-2	MA-BLE-4
Signal Input Adapter	(1) 4-20mA	(2) 4-20mA & RS-485	(4) 4-20mA & RS-485
Signal Output Adapter	(1) 4-20mA	(2) 4-20mA & RS-485	(4) 4-20mA & RS-485
Power Input	100–240VAC (50/60Hz) with 1.0 AMP Fuse		
Power Output	24VDC, 20W		
5PIN Sensor Connection	Requires CC-57M Conversion Adapter Cable - Sold Separately		
7PIN Sensor Connection	Direct to PowerPACK - No Conversion Needed		
8PIN Sensor Connection	Requires CC-78M Conversion Adapter Cable - Sold Separately		
Operational Temperature	32–122 °F (0–50 °C)		
Enclosure Material / Rating	ABS / IP54		
Certificates	CE / RoHS / UKCA / ETL Certified (PowerPACK-4 Only)		

MA-SERIES

Bluetooth® Adapters for Use with uPyxis App.

The MA-Series Inline Adapters are designed to enable Pyxis Lab® sensors to be accessed, viewed, configured and calibrated via Bluetooth® connection and the uPyxis® app. Offered in 5PIN, 7PIN and 8PIN platforms to enable connectivity to any of the sensor designs offered.



KEY FEATURES

- › Offers 4-20mA and RS-485 Modbus Connectivity from the Pyxis Sensor to the Controller
- › Utilizes the power provided (24VDC) from the Controller it is Connected to
- › Live Local Display with Cleanliness Diagnostics and Calibration Hub
- › 5PIN, 7PIN and 8PIN Variants Available for use with any Pyxis Lab® Sensor
- › USB-C Port for Data Download and Remote Power Supply



Item	MA-WA	MA-WB	MA-CR
Part Number	MA-WA	MA-WB	MA-CR
Adapter Pin Format	5PIN	7PIN	8PIN
Sensor Signal Passthrough	RS-485	(1) 4-20mA, RS-485	(2) 4-20mA, RS-485
Local Screen Interface	NO	YES	YES
Power Input	24VDC (±2) @ 10mA from Controller		
Signal Output	RS-485 Modbus via Bluetooth® 5.0		
Enclosure Material	ABS		
Enclosure Rating	IP54		
Operational Temperature	20–140 °F (-7–60 °C)		
Certificates	CE, RoHS		



POWERPACK PRO-5

Bluetooth® + Power Intelligent Auxiliary Adapter.

The PowerPACK Pro-5 Intelligent Adapter is uniquely designed to provide additional power budget and multiple communication methods to drive Pyxis inline sensors to a receiving microprocessor controller or PLC with limited power supply. This auxiliary adapter has built-in power supply with 24W capability and supports up to 5 Pyxis sensors simultaneously.

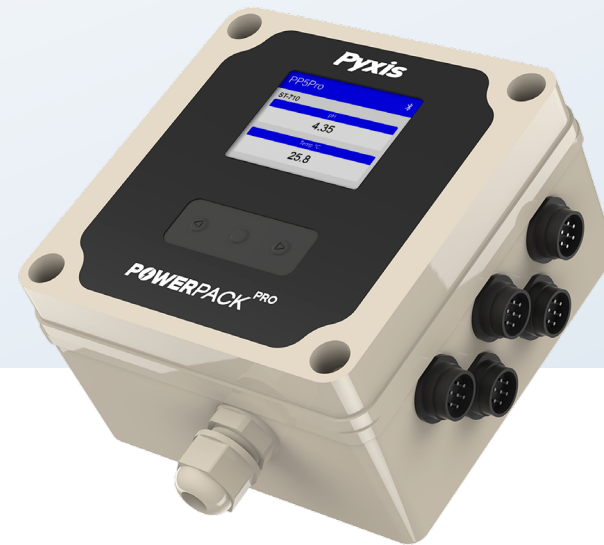

KEY FEATURES

- › Power Supply and Connection up to 5 Pyxis Sensors
- › Local 2.4 inch Color Display of Sensor Readings
- › 4-20mA Signal Output of up to 5 Pyxis Sensors to any Controller (MAX of 10x 4-20mA Outputs)
- › Broad Range External Power Input (100–240VAC)
- › USB-C for Firmware Upgrade & uPyxis® Applications
- › Remotely Accessed via Ethernet (Modbus-TCP) and RS-485 (Modbus-RTU)
- › Bluetooth® 5.0, WiFi (In Development), LoRa Receiver (In Development)



Item	PowerPACK PRO-5
Part Number	MA-PS-5
Power Input	100–240VAC (50/60Hz) with 3.0 AMP Fuse
Power Output	24VDC, 24W
Display	2.4 inch Color Display
USB	(1) USB for Sensor Firmware Updating
Communication	(up to 10) 4-20mA Outputs, Ethernet Port RJ-45 (10MB/s), Bluetooth® 5.0, (1) RS-485 Modbus-RTU, WiFi, LoRa
7PIN Sensor Connection	Direct to PowerPACK - No Conversion Needed
8PIN Sensor Connection	Requires CC-78M Conversion Cable - Sold Separately
Signal Input Adapter	(up to 10) 4-20mA and RS-485
Signal Output Adapter	(up to 10) 4-20mA
Certificates	CE / RoHS / UKCA / ETL

UC-10 NANOVIEW

Portable Display & Data Logging Terminal.

The UC-10 is a portable calibration, diagnostic, display and data logging terminal for rapid and simple maintenance use with Pyxis Lab® sensors only. The device serves as a convenient alternative to the use of mobile smart phones or laptops with the uPyxis app.



KEY FEATURES

- › Portable Sensor Powering, Diagnostics, Calibration and Live Data Display
- › Capable over 10,000 measured Values Storage with Time and Date Stamp
- › Portable and Small Design fits easily in the Pocket
- › 2.4 inch Color Graphic Screen, Visible under direct Sunlight
- › Ideal for Customers not able to use uPyxis App for Sensor Maintenance
- › USB-C Charging Port and Data Export
- › Bluetooth® 5.0 Enabled for Users desiring to use uPyxis Interface



Item	UC-10
Part Number	43062
Operating Temperature	-10–60 °C / 5–95% Relative Humidity
Protection	IP65
Power	USB-C, 5V/1A
Display	2.4 inch Color
Data Export	USB-C, USB Drive
Communication	Bluetooth® 5.0 for Connection to uPyxis
Output/Input	(1) RS-485 Modbus, Suitable for 7PIN and 8PIN Sensors, 5PIN Needs Adapter Cable
Battery	10,000mAh, Standby Time > 24 Hours Continuous (6 Month Warranty)
Data Log	One Year Storage with Built-In 32M Flash Memory
Storage Temperature	-20–70 °C / 5–95% Relative Humidity, No Condensation



UC-60

Touchscreen Display & Data Logging Terminal.

The UC-60 features a 4.3-inch color touchscreen with dual 4–20 mA outputs, RS-485 Modbus, and relay outputs for seamless integration with PLC, SCADA, and DCS systems. Built for industrial environments, it offers IP65 protection, USB data access, and optional Pyxis 4G CloudLink™ connectivity for remote monitoring.



KEY FEATURES

- › (2) 4-20mA and (1) RS-485 Modbus Outputs
- › (2) SPST Relays (Dry Contact)
- › USB Interface for Data Download and Firmware Upgrades
- › 4.3inch Touchscreen & Button Interface
- › CloudLink™ 4G LTE Gateway Pre-Installed & Activated Upon Request



Item	UC-60
Part Number	79262
Display	4.3 inch Color Touchscreen
Analog Outputs	(2) 4-20mA Current Outputs
Digital Outputs	(1) Isolated RS-485 Modbus-RTU
Relay Output Type	(2) SPST Relays (Dry Contact), Contact Rating: 5A 250VAC/30VDC
Power Supply	100–240VAC 50/60Hz
USB Interface	For Data Downloading and Firmware Upgrade
Operating Temperature	32–122 °F (0–50 °C)
Humidity	5–95% No Condensation
Protection	IP65
CloudLink™ 4G Gateway	Included & Activated upon Request with Enrollment - Contact Pyxis Lab@ for Details

UC-80 SERIES

Touchscreen Displays & Data Logging Terminals.

The UC-80 are preconfigured, color, touch-screen Display & Data Logging Terminals that connect to any (up to 8) Pyxis Lab, Inc. sensor via 4-20mA and RS-485 Modbus. Preconfigured based on the sensor of use, this display offers rapid deployment and simple user setup.



KEY FEATURES

- › May be installed as Stand-Alone Device or Directly Wired to any Controller, PLC or DCS Network
- › 4.3 inch Touchscreen Display & Data Logging Terminal
- › Connect up to 4 Pyxis Lab@ Sensors via RS-485 Modbus
- › Arrives Pre-Configured based on the Sensor of Use
- › Live Display & Historical Data Trend Charts for Each Sensor Input
- › Sensor Calibration Interface



Item	UC-80	UC-80 PLUS
Part Number	14003	72875
Display	4.3 inch LCD Color Touchscreen	7 inch LCD Color Touchscreen
Output	(2) 4-20mA, RS-485 Modbus RTU + TCP	(8) 4-20mA, RS-485 Modbus RTU + TCP
Input	(2) 4-20mA, RS-485 Modbus RTU + TCP	(4) 4-20mA, RS-485 Modbus RTU + TCP
LoRa	NOT INCLUDED	INCLUDED
Measurement Interval	Continuous Measurement	
Storage Capacity	Built-In 128MB of RAM for Storing up to 1 Million Data/Event Records	
Power Requirement	96–260VAC / 50–60Hz; 60W	
USB	(1) USB Host for Data Downloading and Screen Upgrade	
Relay	(2) 24VDC Relays (Passive Output or Active Output - User Selected)	
Rating / Regulation	IP64 / CE, RoHS	
CloudLink™ 4G LTE Gateway	Included & Activated upon Request with Enrollment - Contact Pyxis Lab@ for Details	



UC-100A SERIES

Touchscreen Display & Data Logging Terminal.

A microprocessor-based touchscreen display and data logging terminal that can connect up to 4 Pyxis sensors via RS-485.

The UC-100A Series provide live display and historical data trend charts for each sensor input as well as sensor calibration interface while logging data for all inputs via USB download or transmission via Modbus RTU and/or Modbus-TCP.



KEY FEATURES

- › May be installed as Stand-Alone Device or Directly Wired to Controller, PLC or DCS
- › Arrives Equip with Two Extra 4-20mA Inputs
- › Outputs can be used to Log Data from Non-Pyxis Analog Device
- › Connect up to 4 Pyxis Lab® Sensors via RS-485
- › 7 inch Touchscreen Display



Item	UC-100A	UC-100AG	UC-100AGS
Part Number	43054	43055	43056
CloudLink™ 4G LTE Gateway	N/A	Included	Included
Prepaid Global SIM	N/A	N/A	1 Year Prepaid Included
Power	110/220VAC, 50/60Hz, 30W		
Display	7 inch 4-Wire Resistant Color Touchscreen Display		
Output	(2) 4-20mA, RS-485 Modbus-RTU, Modbus-TCP		
Input	(2) 4-20mA, RS-485 Modbus		
Relay	NONE		
Internet	RJ-45 Socket, Modbus-TCP		
Data Storage	4GB, up to 1 million data entries or events		
USB	(1) USB Host for Data Download and Screen Upgrade		
Protection	IP65		

TC-22XP SERIES

PowerCloud™ 4G LTE Gateway with Display & Power.

An industrial 4G LTE gateway with external power supply and live local touchscreen display of sensor readings. Allows users to power and remotely monitor several Pyxis Lab® sensors. Contains the CloudLink™ 4G LTE Gateway that offers RS-485 Modbus and/or (8) 4-20mA Inputs contained in a Nema 4X enclosure box.

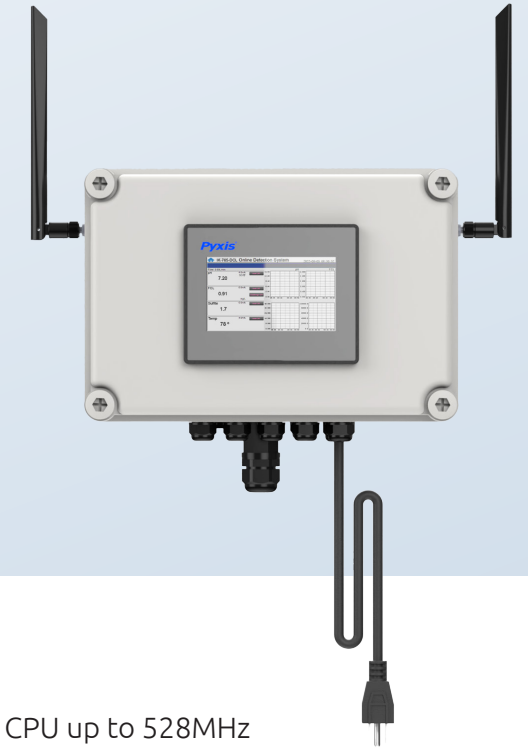

KEY FEATURES

- › High Performance Hardware Platform Features ARM Cortex-A7 CPU up to 528MHz
- › LoRa Gateway support via Private Protocol
- › LTE Cat 4 Module Optimized for M2M and IoT Applications
- › Major Carriers Supported (AT&T, Verizon, T-Mobile)
- › Support 8-Channel 4-20mA Inputs
- › Intuitive Web Interface for System Commissioning and Configuration



Item	TC-220P	TC-221P
Part Number	43035	43036
CPU	ARM Cortex A-8 32bit Processor	ARM Cortex A-8 32bit Processor
Memory/Storage	Up to 512MB/4GB up to 68GB Support	Up to 512MB/4GB up to 68GB Support
Ethernet Port	(1) RJ-45 (10/100 Base-T)	(1) RJ-45 (10/100 Base-T)
Serial Port	(1) RS-485 with 24V Output	(1) RS-485 with 24V Output
Analog Output	N/A	(8) 0-20mA / 4-20mA
Antenna Connector	x1 50Ω SMA (Center Pin: Female)	x1 50Ω SMA (Center Pin: Female)
LTE Category	4G	4G
Bands Supported	B1/2/3/4/5/6/7/12/13/14/20/28/66/71	B1/2/3/4/5/6/7/12/13/14/20/28/66/71
Carriers Supported	AT&T, T-Mobile, Verizon	AT&T, T-Mobile, Verizon
Protocols Supported	IP/TCP/UDP/HTTP/HTTPS/Modbus	IP/TCP/UDP/HTTP/HTTPS/Modbus
WiFi Connectivity	IEEE 802.11 b/g/n radio	IEEE 802.11 b/g/n radio



STANDARDS & REAGENTS



Pyxis Lab's calibration solutions and reagents are engineered to ensure accurate, consistent sensor performance across all water treatment applications. Formulated for stability and ease of use, these solutions support reliable calibration and verification processes, helping operators maintain data integrity, reduce drift, and extend the life of their analytical instrumentation.

CALIBRATION SOLUTIONS

All Necessary Calibration Standards.

Pyxis Lab, Inc. provide a comprehensive portfolio of single and combined calibration solutions to maintain measurement accuracy and sensor reliability.

Our calibration standards and verification solutions are specifically formulated to support precise calibration for multiple water quality parameters across industrial, environmental, and process monitoring applications.



CLEANING KITS

Sensor & Handheld Cleaning Kits.

Our cleaning kits help ensure the accuracy of readings for inline and handheld devices. Pyxis Lab® recommends a minimum cleaning frequency of once per month be maintained dependent on application needs and foulant level.



Parameter	Descrip
PTSA	PTSA Calibration Standard Solutions - 30, 50, 100, 200, 300ppb
PTSA-1010	Combined PTSA 100ppb + Conductivity 1,000µS/cm Standard Solution
PTSA-100FL	Combined PTSA 100ppb + Fluorescein 10ppb
PTSA-100-50FL	Combined PTSA 100ppb + Fluorescein 50ppb Calibration Standard Solution
TAG	Tagged Polymer Calibration Standard Solutions - 10, 20ppm
PTAG-1010	Combined PTSA 100ppb + Tagged Polymer 10ppm Calibration Standard Solution
FLUO	Fluorescein Calibration Standard Solutions - 20, 50, 200, 250, 500, 800ppb
Conductivity	Conductivity Calibration Standard Solutions - 100, 1,000, 50,000µS/cm
pH	pH Calibration Standard Solutions - 4, 7, 10 and Combo Pack
ORP-200	ORP 200mV Calibration Standard Solution
TTA	TTA Calibration Standard Solutions - 1, 2ppm
CHLORO-A	Chlorophyll-A Calibration Standard Solutions - 10, 20, 50ppb
OIW	Oil-In-Water Calibration Standard Solutions - 100, 500, 1,000ppb
Turbidity	Turbidity Calibration Standard Solutions - 5, 10, 15, 20, 30, 50, 100, 200, 500, 1,000NTU and Combo Pack
NDSA	NDSA Calibration Standard Solutions - 10, 50, 100ppb
COLOR	APHA/Hazen Color Calibration Standard Solution - 30 Degree
TURB-PG25	PG25 Coolant Calibration Standard Solutions - 2, 10, 50NTU
ABS	ABS Colorimetric Verification Kits - 420, 455, 525, 560, 570, 630nm
SUGAR	Sugar Synthetic Calibration Standard Solutions - 200, 400ppm
DPD	DPD Chlorine Secondary Verification Standard - 1, 2ppm

DETAILS

- › Custom Blend of Organic Acid/Reducing Agent and Surfactant
- › Targets Inorganic Fouling and Deposition
- › Will NOT Damage Inline or Handheld Devices
- › 500mL Bottle sufficient for Multiple Cleanings
- › Cleaning Procedure Provided on Bottle
- › Cotton Swabs and Pipe Brush Cleaning Included

GENERAL PROCEDURE

- › Soak device in Cleaning Kit Solution for 30 minutes
- › Use Cotton Swabs and/or Pipe Cleaner to gently remove Excessive Deposit after soaking
- › Rinse with DI Water then Check Light Source inside the Inline or Handheld Device
- › If surface is not entirely clean, soak the device for an additional 30 minutes, then repeat check



REAGENTS

Powder Pillow DPD Reagents for Devices.

Our powder pillow reagents provide a convenient and reliable solution for colorimetric water testing. Pre-measured and sealed for accuracy and stability, these reagents ensure consistent results while simplifying preparation for laboratory and field analysis.



Part Number	Description
31002	CL-F Free Chlorine 10mL - 100 Pack
31111	CL-F Free Chlorine 10mL - 1,000 Pack
31014	CL-T Total Chlorine 10mL - 100 Pack
31113	CL-T Total Chlorine 10mL - 1,000 Pack
31016	CLO2-1 Chlorine Dioxide 10mL - 100 Pack CLO2-2 Chlorine Dioxide 10mL - 100 Pack
31035	NG3S-1 Nitrogen, Ammonia 10mL - 100 Pack NG3S-2 Nitrogen, Ammonia 10mL - 100 Pack
31036	NH2C Monochloramine Low Range 10mL - 100 Pack
31063	Br-T Bromine 10mL - 100 Pack
31015	CL2H Free Chlorine High Range 10mL
31060	CL2-TH Total Chlorine High Range 10mL
31074	CL2UH - Free Chlorine Ultra-High Range 10mL
31079	PAA - Peroxyacetic Acid 10mL - 100 Pack
31117	H2O2 Hydrogen Peroxide High Range 10mL - 100 Pack
31124	H2O2 Hydrogen Peroxide Low Range 10mL - 100 Pack
31118	O3 Ozone 10mL - 100 Pack



REAGENTS

DPD Liquid Dropper Reagent with Long Life!

A revolutionary Liquid DPD Free/Total Chlorine Reagent that offers a long shelf life of 6-12 months. One to three drop testing allows users to test for Free or Total Chlorine 900–1,000 times with just one 30mL bottle.



DETAILS

- › Does NOT Stain Glass Vials
- › Long Shelf Life of 6-12 Months
- › 0–2ppm use 1 Drop
- › 0–10ppm use 3 Drops
- › Available in Free Chlorine or Total Chlorine
- › Up to 1,000 Tests per 30mL Bottle

Part Number	Description
35262	Free Chlorine Liquid DPD Dropper Test Kit - 30mL
39879	Total Chlorine Liquid DPD Dropper Test Kit - 30mL



MFA-SERIES

Unique Reagent Cartridges for MFA-Series Analyzers.

Injection-molded disposable reagent cartridge that includes an integrated reagent dispersing mechanism. Once empty, cartridges are quickly replaced as a single sealed assembly. Cartridge life ranges from approximately 4,000–16,000 tests depending on model, chemistry and measurement intervals on the MFA-Series Analyzer.

**MEASUREMENT PROCESS**

The Titronex™ MFA-Series analyzers operate using a controlled, pressurized process-flow architecture designed to deliver stable and repeatable colorimetric measurements with minimal water consumption. Process water enters the analyzer through a 316L stainless sample inlet and passes through an integrated ultrasonic flow controller that continuously regulates flow using a motorized valve to maintain a constant, programmable sample rate. During standby or sample-wait periods, a three-way valve directs water to bypass the reaction chamber and either discharge to drain in constant-flow mode or remain isolated in water-savings mode to prevent unnecessary water loss. When a measurement cycle begins, the valve automatically redirects the regulated sample into the colorimetric chamber where precise reagent volumes are introduced from the sealed injection-molded cartridge using a gravity-assisted tube-roller dispensing mechanism — eliminating traditional metering pumps. The sample and reagent are mixed within the chamber to form the absorbance-based reaction, after which the reacted solution is discharged through the waste outlet. Following the analysis, the system returns to a controlled wait state where flow is stabilized and the chamber remains protected from fouling until the next scheduled measurement, ensuring repeatable results with reduced maintenance and minimal reagent and water consumption.

Part Number	Analyzer	Description
37109	MFA-600	Hardness-600 Calcium Hardness Reagent, 12 Month Shelf Life, Up to 4,000 Tests
36421	MFA-100	FCL-100 Free Chlorine Reagent, 6 Month Shelf Life, Up to 16,000 Tests
35700	MFA-110	TCL-100 Total Chlorine Reagent, 6 Month Shelf Life, Up to 16,000 Tests
31719	MFA-310	Phosphate-310 Orthophosphate Reagent, 12 Month Shelf Life, Up to 8,000 Tests
30545	MFA-400	Polymer-400 Anionic Polymer Reagent, 12 Month Shelf Life, Up to 16,000 Tests

**TRACER CHEMICAL**

PTSA Tracer Product for Cooling & Process Water.

PTSA (1,3,6,8-Pyrenetetrasulfonic Acid, Tetrasodium Salt, CAS# 59572-10-0) provide a reliable method for monitoring and controlling chemical dosing in water treatment systems. Using fluorescent PTSA technology, these tracers enable accurate, real-time verification of product feed rates, helping operators maintain proper treatment levels while improving system efficiency and performance.

**DETAILS**

- › Active Ingredient - 1,3,6,8-Pyrenetetrasulfonic Acid, Tetrasodium Salt (PTSA), CAS# 59572-10-0
- › High Quantum Efficiency, Ideal for monitoring as low as 50ppb for Cooling and 5ppb for RO
- › Colorless at the Target Concentrations & Easy to Dissolve/Blend
- › Inert Fluorescent Tracer with Great Compatibility with Water Treatment Chemical Formulations
- › Long Term Stability, 3 Year Shelf Life within the Original Packaging

Part Number	Description
20201-T	FDX-10 PTSA 10% Liquid - 2,200lbs Tote (275 Gallons)
20201-D	FDX-10 PTSA 10% Liquid - 440lbs Drum (55 Gallons)
20201-P	FDX-10 PTSA 10% Liquid - 40lbs Pail (5 Gallons)
20201-L	FDX-10 PTSA 10% Liquid - 500mL Bottle (0.5L)
20303	FDX-98 PTSA 98% Powder - 55lbs Fiber Drum
20303-50G	FDX-98 PTSA 98% Powder - 50g Vial (2x 25mL Vial Full)
20303-500G	FDX-98 PTSA 98% Powder - 500g Bottle (500mL Bottle Full)



SOFTWARE SOLUTIONS

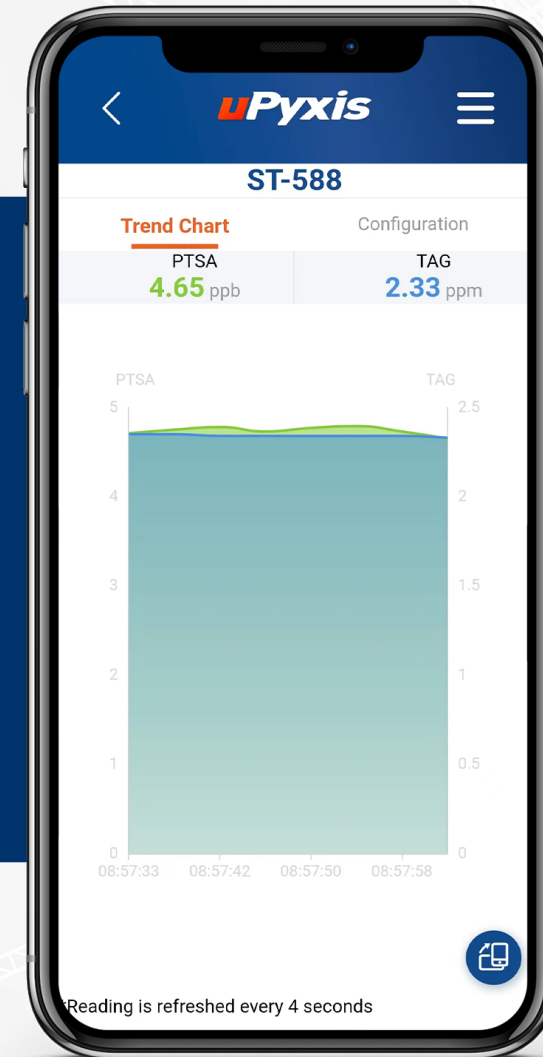

Pyxis Lab's software solutions, including the uPyxis® mobile app and Cloud Data Management System, provide powerful tools for configuring, calibrating, and monitoring sensors with ease. From on-site Bluetooth® access to centralized cloud-based data management, these platforms deliver real-time insights, streamline workflows, and enable smarter, more efficient water treatment operations.



UPYXIS APP

Monitor, Configure, Calibrate & Share Data **Wirelessly.**

Download uPyxis® 2.0 to unlock mobile calibration, configuration, monitoring, sensor diagnostics and data sharing capabilities from your smartphone, laptop or desktop computer. Available on the App Store or Google Play.

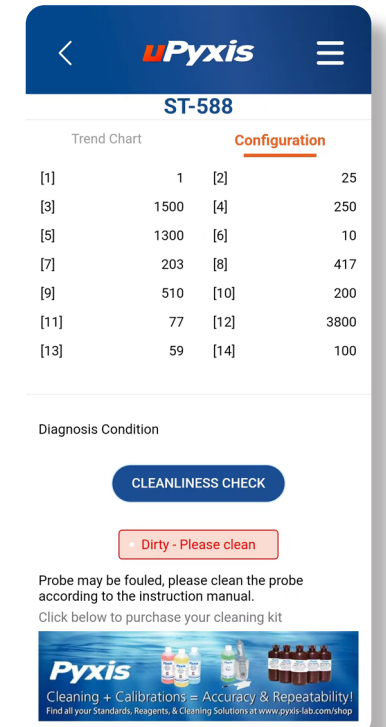
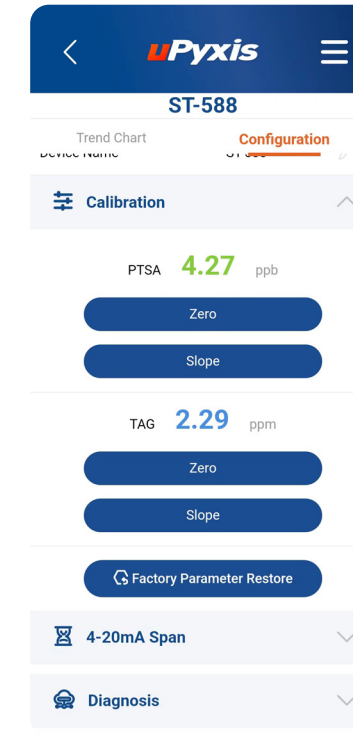
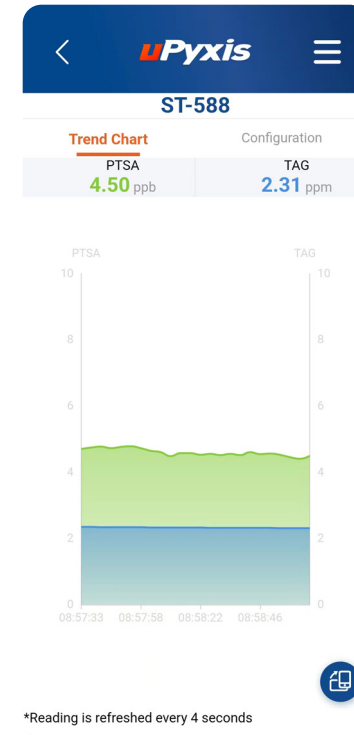

MOBILE MONITORING + CALIBRATION.

Monitor your sensors with live reading displays on your phone or computer. Get within range of your Pyxis Lab® device and live data charts/readings will display under the 'Reading' tab. Conduct calibration processes directly through the app!

CONFIGURE DEVICES TO FIT YOUR SYSTEM.

Change internal settings like device name, screen shut-off time, excitation wavelengths, product factors, application specifications & more to help match your specific application and ensure accurate readings.

WIRELESS SENSOR DIAGNOSTICS.

Keep up on the quality of your inline sensors by running the Pyxis Lab® Cleanliness Check directly on your uPyxis® app. Simply select the 'Cleanliness Check' option and the uPyxis® app will immediately notify whether your sensor is 'Clean' or 'Dirty'.

RAPID DATA SHARING.

Quickly send your data findings to over text, email or your favorite app. Save your data as a .CSV file to create a spreadsheet.

DOWNLOAD SUPPORT DOCUMENTATION.

Access the support you need, right in the field. With the uPyxis® app, users can easily download product manuals, calibration guides, and technical documentation—ensuring quick reference and troubleshooting wherever you may be.

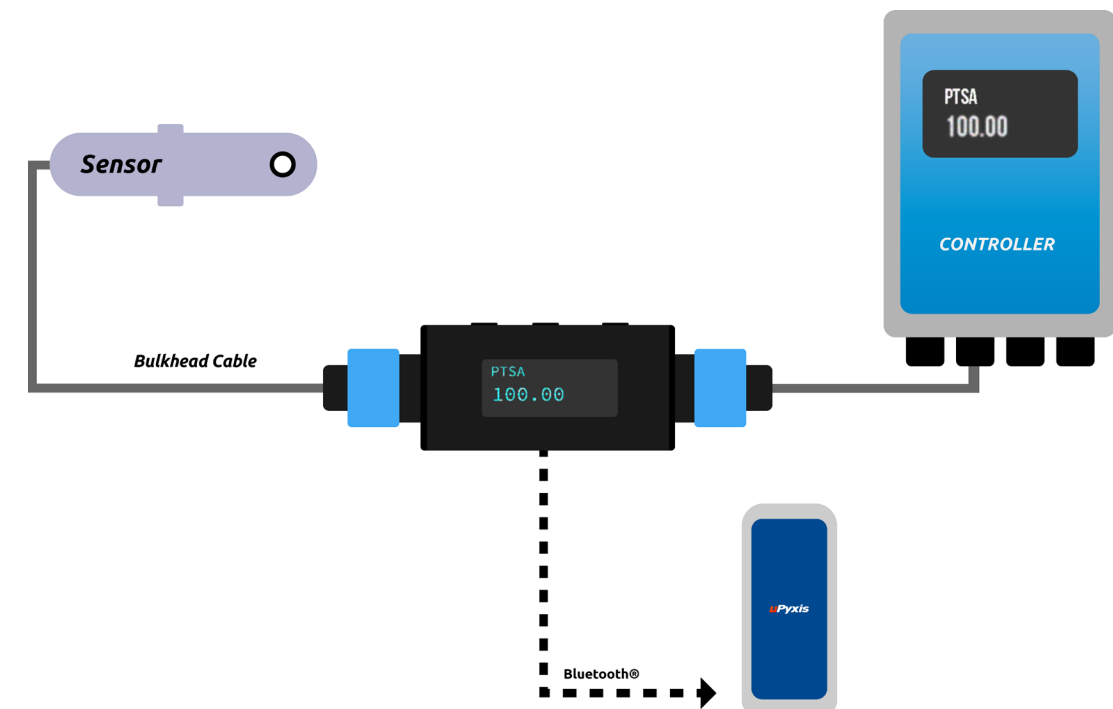



CLOUD DATA MANAGEMENT

Monitor & Configure Anytime, Anywhere.

Utilize the CloudLink™ 4G LTE Gateway to easily send data to our Cloud Data Management Platform for remote monitoring, alarm configuration, user notification and more.



ALL YOUR ACCOUNTS IN ONE PLACE.

Manage every site, system and user from one place with the Pyxis Lab® Cloud Data Management System. Simple, secure, connected.

LIVE DATA, REAL INSIGHTS.

Track every parameter in real time with our Cloud Dashboard. View live trends, set alarms and visualize system data across all your accounts – anywhere, anytime.

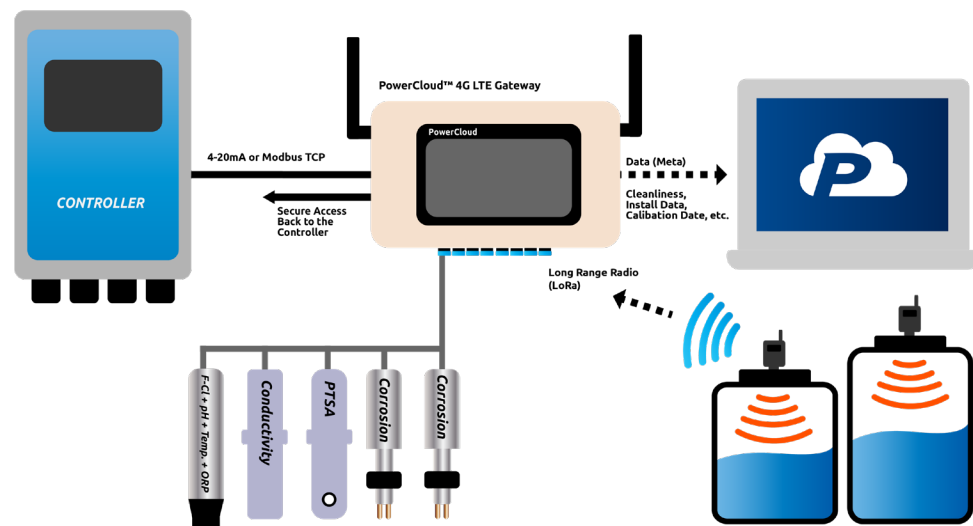

A CENTRALIZED DATA DASHBOARD.

Trend acquired data, set alarms, generate reports, and create user permission roles all in one central hub.

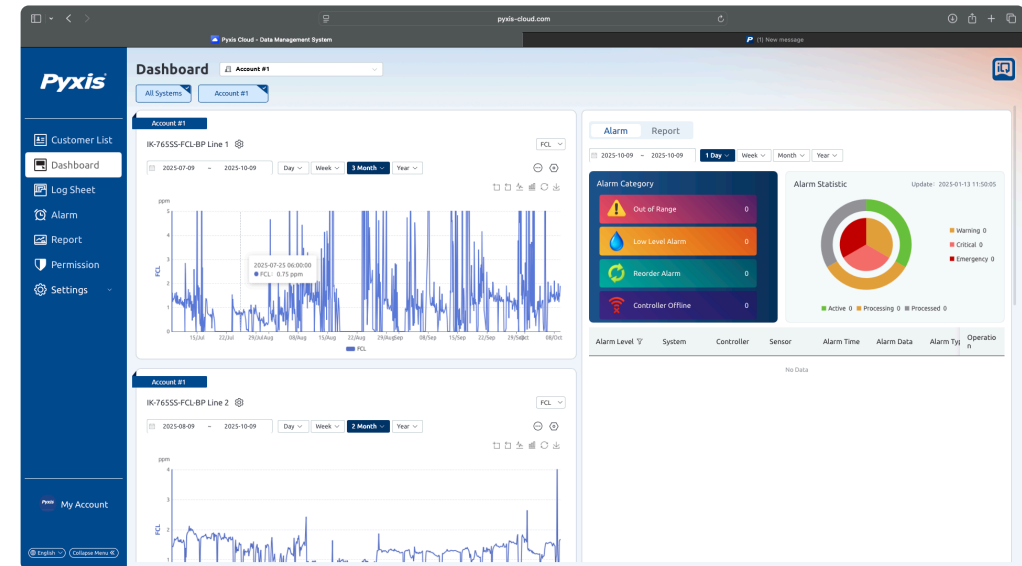

MEET WATER ARTIFICIAL INTELLIGENCE.

Introducing FlowIQ™, a smart support platform built to assist you with real-time technical help, troubleshooting and application guidance.



Pyxis[®]

 order@pyxis-lab.com

 21242 Spell Circle, Tomball TX 77375

 +1 (866) 203-8397