

# Pyxis<sup>®</sup>

## ST-500 Series Inline PTSA Sensors User Manual



Water Professionals Deserve Better Tools.  
[www.pyxis-lab.com](http://www.pyxis-lab.com)

# ST-500 Series Inline PTSA Sensors User Manual

January 10, 2022  
Rev. 3.08

**Pyxis Lab, Inc.**  
1729 Majestic Dr. Suite 5  
Lafayette, CO 80026 USA  
[www.pyxis-lab.com](http://www.pyxis-lab.com)

## Table of Contents

<b>1</b>	<b>Introduction</b>	<b>2</b>
<b>2</b>	<b>Specifications</b>	<b>3</b>
<b>3</b>	<b>Unpacking Instrument</b>	<b>3</b>
3.1	Standard Accessories . . . . .	3
3.2	Optional Accessories . . . . .	4
<b>4</b>	<b>Installation</b>	<b>5</b>
4.1	ST-500 and ST-500RO Piping . . . . .	5
4.2	ST-500SS Piping . . . . .	6
4.3	Wiring . . . . .	7
4.4	Connecting via Bluetooth . . . . .	7
<b>5</b>	<b>Setup and Calibration with uPyxis® Mobile App</b>	<b>8</b>
5.1	Download uPyxis® Mobile App . . . . .	8
5.2	Connecting to uPyxis® Mobile App . . . . .	9
5.3	Calibration Screen and Reading . . . . .	10
5.4	Diagnosis Screen . . . . .	11
5.5	Device Info Screen . . . . .	11
<b>6</b>	<b>Setup and Calibration with uPyxis® Desktop App</b>	<b>12</b>
6.1	Install uPyxis® Desktop App . . . . .	12
6.2	Connecting via USB . . . . .	12
6.3	Connecting to uPyxis® Desktop App . . . . .	13
6.4	Information Screen . . . . .	14
6.5	Calibration Screen . . . . .	14
6.6	Diagnosis Screen . . . . .	15
<b>7</b>	<b>Outputs</b>	<b>15</b>
7.1	4–20mA Output Setup . . . . .	15
7.2	Adjusting 4–20mA Span . . . . .	16
7.3	Communication using Modbus RTU . . . . .	17
<b>8</b>	<b>Sensor Maintenance and Precaution</b>	<b>17</b>
8.1	Methods to Cleaning the ST-500 Series Sensor . . . . .	17
8.2	Storage . . . . .	18
<b>9</b>	<b>Troubleshooting</b>	<b>18</b>
<b>10</b>	<b>Contact Us</b>	<b>19</b>

## **Warranty Information**

### **Confidentiality**

The information contained in this manual may be confidential and proprietary and is the property of Pyxis Lab, Inc. Information disclosed herein shall not be used to manufacture, construct, or otherwise reproduce the goods described. Information disclosed herein shall not be disclosed to others or made public in any manner without the express written consent of Pyxis Lab, Inc.

### **Standard Limited Warranty**

Pyxis Lab warrants its products for defects in materials and workmanship. Pyxis Lab will, at its option, repair or replace instrument components that prove to be defective with new or remanufactured components (i.e., equivalent to new). The warranty set forth is exclusive and no other warranty, whether written or oral, is expressed or implied.

### **Warranty Term**

The Pyxis warranty term is thirteen (13) months ex-works. In no event shall the standard limited warranty coverage extend beyond thirteen (13) months from original shipment date.

### **Warranty Service**

Damaged or dysfunctional instruments may be returned to Pyxis for repair or replacement. In some instances, replacement instruments may be available for short duration loan or lease.

Pyxis warrants that any labor services provided shall conform to the reasonable standards of technical competency and performance effective at the time of delivery. All service interventions are to be reviewed and authorized as correct and complete at the completion of the service by a customer representative, or designate. Pyxis warrants these services for 30 days after the authorization and will correct any qualifying deficiency in labor provided that the labor service deficiency is exactly related to the originating event. No other remedy, other than the provision of labor services, may be applicable.

Repair components (parts and materials), but not consumables, provided during a repair, or purchased individually, are warranted for 90 days ex-works for materials and workmanship. In no event will the incorporation of a warranted repair component into an instrument extend the whole instrument's warranty beyond its original term.

### **Warranty Shipping**

A Repair Authorization (RA) Number must be obtained from Pyxis Technical Support before any product can be returned to the factory. Pyxis will pay freight charges to ship replacement or repaired products to the customer. The customer shall pay freight charges for returning products to Pyxis. Any product returned to the factory without an RA number will be returned to the customer. To receive an RMA you can generate a request on our website at <https://pyxis-lab.com/request-tech-support/>.

### **Pyxis Technical Support**

Contact Pyxis Technical Support at +1 (866) 203-8397, [service@pyxis-lab.com](mailto:service@pyxis-lab.com), or by filling out a request for support at <https://pyxis-lab.com/request-tech-support/>.

## 1 Introduction

The Pyxis ST-500 Series inline fluorometer sensor measures the concentration of fluorescence tracer PTSA (pyrenetetrasulfonic acid) in water. The standard ST-001 Tee Assembly provided with each ST-500/ST-500RO sensor, has two 3/4" female NPT ports and can be placed to an existing 3/4" sample water line. Pyxis Lab also offers 2" and 3" Tee formats for larger flow installations. The 4–20mA current output of the ST-500 Series sensor can be connected to any controller that accepts an isolated or non-isolated 4–20mA input. The ST-500 Series sensor is a smart device. In addition to measuring fluorescence, the ST-500 Series sensor has an extra photo-electric components that monitors the color and turbidity of the sample water. This extra feature allows automatic color and turbidity compensation to eliminate interference commonly associated with real-world waters.

The Pyxis ST-500 Series sensor has a short fluidic channel and can be easily cleaned. The fluidic and optical arrangement of the ST-500 Series sensor is designed to overcome shortcomings associated with other fluorometers that have a distal sensor surface or a long, narrow fluidic cell. Traditional inline fluorometers are susceptible to color, turbidity interference, and fouling, making them very difficult to properly clean.

The Pyxis ST-500 Series sensor uses a narrow wavelength band gallium phosphide photodiode and high temperature-tolerant and humidity-resistant optical filters. This combination greatly enhances the robustness of the sensor. It can be operated under a wide range of ambient conditions without the need of humidity and temperature regulation. The performance of the ST-500 Series sensor can be stable and consistent for a long period of time.

## 2 Specifications

Table 1. ST-500 Series Specifications

Specification*	ST-500	ST-500RO	ST-500SS
Part Number (P/N)	50661	50669	50700
PTSA Range	0–300 ppb	0–40 ppb	0–300 ppb
PTSA Resolution	0.01 ppb		
PTSA Accuracy	±1% of reading		
Calibration	Two-point calibration against standard solution		
Outputs	4–20mA Analog Output, RS-485 Digital Output with Modbus protocol		
Installation	Custom tee assembly (P/N: ST-001) with 3/4" FNPT socket & threaded ports	Custom tee assembly (P/N: ST-001) with 3/4" FNPT socket & threaded ports	3/4" FNPT threaded ports
Cable Length	5 ft with IP67 connectors		
Power Supply	22–26 VDC, 1 W		
Dimension (L × Dia) †	6.8 × 1.44 inch (172.7 × 36.6 mm)		
Weight	0.37 lbs (170 g)	0.37 lbs (170 g)	2.5 lbs (1130 g)
Material	CPVC	CPVC	304 Stainless Steel
Operational Temperature	40–120 °F (4–49 °C)		
Storage Temperature	-4–140 °F (-20–60 °C)		
Pressure	Up to 100 psi (0.7 MPa)	Up to 100 psi (0.7 MPa)	Up to 290 psi (2.0 MPa) at 149 °F (65 °C)
Enclosure Rating	IP67		
Regulation	CE		

\* With Pyxis's continuous improvement policy, these specifications are subject to change without notice.

† See Figure 4 for ST-500SS dimensions.

## 3 Unpacking Instrument

Remove the instrument and accessories from the shipping container and inspect each item for any damage that may have occurred during shipping. Verify that all accessory items are included. If any item is missing or damaged, please contact Pyxis Lab Customer Service at [service@pyxis-lab.com](mailto:service@pyxis-lab.com).

### 3.1 Standard Accessories

- Tee Assembly 3/4" NPT (1x Tee, O-ring, and Nut) P/N: ST-001  
**\*NOTE\*** ST-001 is not included for ST-500SS
- 7-Pin Female Adapter/Flying Leads Cable (2 ft) P/N: MA-1100
- User Manual available online at <https://pyxis-lab.com/support/>

### 3.2 Optional Accessories

The following optional accessories can be ordered from Pyxis Customer Service ([order@pyxis-lab.com](mailto:order@pyxis-lab.com)) or Pyxis E-Store at <https://pyxis-lab.com/shop/>.





<b>Pyxis</b> PYXIS INLINE SENSOR ACCESSORIES - SELECT*A*GUIDE <b>Pyxis</b>		
Accessory Name/Description	Part Number	Photo
Pyxis ST Series Cleaning Kit <i>(Includes 500mL Sensor Cleaner / Qtips &amp; Pipe Cleaners)</i>	SER-01	
0.75" NPT Inline Sensor Tee Assembly <i>(All ST Series Sensors)</i>	50704	
2.0" NPT Inline Sensor Tee Assembly <i>(All ST Series Sensors)</i>	50756	
3.0" NPT Inline Sensor Tee Assembly <i>(All ST Series Sensors)</i>	50775	
ST-002 Inline Sensor Removal PLUG <i>(Allows ST Sensor Removal)</i>	ST-002	
ST Sensor Tee Replacement O-Ring <i>(All ST Series Tee's)</i>	MA-150	
MA-WB Bluetooth Adapter for All ST Series Sensors <i>(4-20mA &amp; RS-485)</i>	MA-WB	
MA-485 USB Adapter for All ST Series Sensors <i>(4-20mA RS-485)</i>	MA-485	
Bluetooth PC to Handheld Adapter <i>(For uPyxis Firmware Updates)</i>	MA-NEB	
PowerPack 1 <i>(Single Channel Power Supply w/Bluetooth)</i>	MA-BLE-1	
PowerPack 4 <i>(Four Channel Power Supply w/Bluetooth)</i>	MA-BLE-4	
MA-1100 <i>(24" Flying Lead Cable for All ST Sensors)</i>	MA-1100	
MA-C10 <i>(10' Extension Cable for All ST Sensors)</i>	50738	
MA-C50 <i>(50' Extension Cable for All ST Sensors)</i>	50705	

Figure 1.

<b>Pyxis®</b>		<b>PYXIS PTSA STANDARDS: SELECT-A-GUIDE</b>					<b>Pyxis®</b>
Product Specification	PTSA-30	PTSA-50	PTSA-100	PTSA-200	PTSA-300	PTSA-1010	
P/N	PTSA-30	21002	21001	21000	21003	21004	
PTSA (ppb)	30 ± 0.5	50 ± 0.5	100 ± 1	200 ± 2	300 ± 3	100 ± 1	
Conductivity (µS)	< 20	< 20	< 20	< 20	< 20	1000 ± 10	
Container (oz. / mL)				16 / 500			
Storage Condition (°F)				40-104			
Shelf Life (Months)				6			
Net Volume (mL)				510 ± 10			
Total Weight (g)				600 ± 10			
Net Weight (g)				510 ± 10			

**Figure 2.**

## 4 Installation

### 4.1 ST-500 and ST-500RO Piping

The provided ST-001 Tee Assembly can be connected to a pipe system through the 3/4" female ports, either socket or NPT threaded. To properly install the ST-500/ST-500RO sensor into the ST-001 Tee Assembly, follow the steps below:

1. Insert the provided O-ring into the O-ring groove on the tee.
2. Insert the ST-500/ST-500RO sensor into the tee.
3. Tighten the tee nut onto the tee to form a water-tight, compression seal.

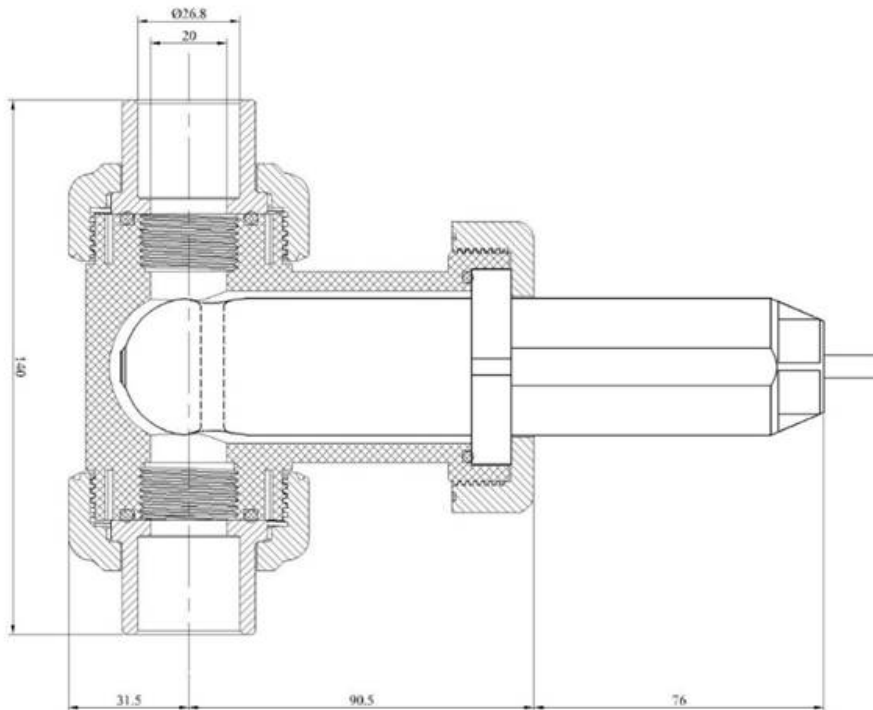

**Figure 3.** Dimension of the ST-500/ST-500RO and the ST-001 Tee Assembly (mm)

## 4.2 ST-500SS Piping

The ST-500SS sensor has 3/4" female NPT threaded ports on the sensor itself and therefore does not require a custom tee assembly. It is recommended that two 3/4" NPT to 1/4" tubing adapters are used to connect the sensor to the sampling system. Sample water entering the sensor must be cooled down to below 120 °F (49 °C). The sensor can be held by a 1.75-inch pipe clamp or mounted to a panel with four 1/4-28 bolts. See Figure 4 for ST-500SS dimensions.

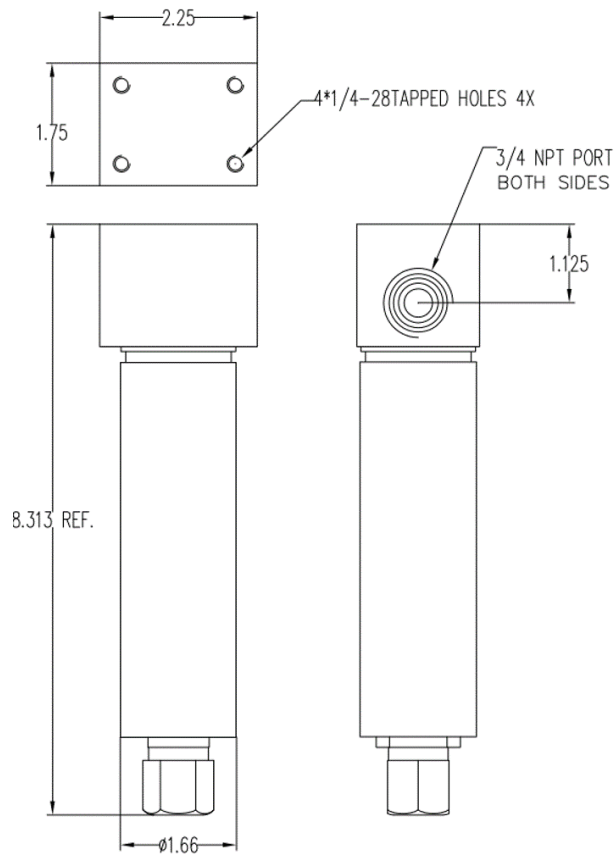

**Figure 4.** Dimension of the ST-500SS (inch)

### 4.3 Wiring

If the power ground terminal and the negative 4–20mA terminal in the controller are internally connected (non-isolated 4–20mA input), it is unnecessary to connect the 4–20mA negative wire (green) to the 4–20mA negative terminal in the controller. If a separate DC power supply other than that from the controller is used, make sure that the output from the power supply is rated for 22–26 VDC @ 65mA.

**\*NOTE\*** *The negative 24V power terminal (power ground) and the negative 4–20mA terminal on the ST-500 Series sensor are internally connected.*

Follow the wiring table below to connect the ST-500 Series sensor to a controller:

**Table 2.**

Wire Color	Designation
Red	24V +
Black	24V Power ground
White	4–20mA +
Green*	4–20mA -
Blue	RS-485 A
Yellow	RS-485 B
Clear	Shield, earth ground

\* Internally connected to the power ground

### 4.4 Connecting via Bluetooth

A Bluetooth adapter (P/N: MA-WB) can be used to connect a ST-500 Series sensor to a smart phone with the **uPyxis®** Mobile App or a computer with a Bluetooth/USB Adapter (P/N: MA-NEB) and the **uPyxis®** Desktop App. The power should be sourced from a 24 VDC power terminal of a controller. If a controller is not available, please purchase a Pyxis PowerPack-1 (P/N: MA-BLE-1) or PowerPack-4 (P/N: MA-BLE-4) auxiliary power supply with Bluetooth, or an alternative 24 V power supply that can directly connect to the ST-500 Series sensor with proper cable connectors from Pyxis.

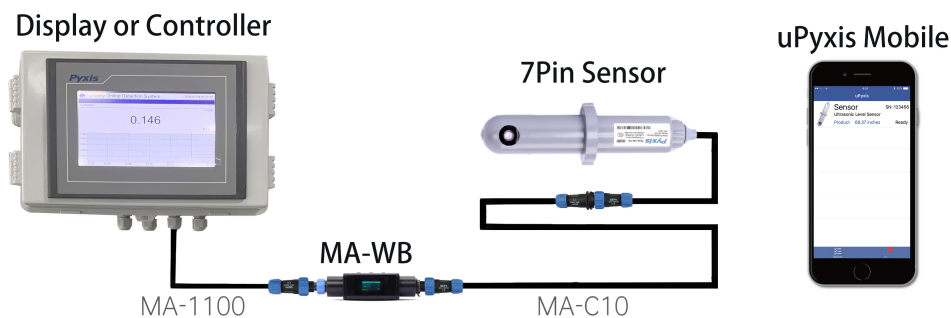

**Figure 5.** 7-Pin Sensor with MA-WB and uPyxis Mobile

## 5 Setup and Calibration with uPyxis® Mobile App

### 5.1 Download uPyxis® Mobile App

Download uPyxis® Mobile App from [Apple App Store](#) or [Google Play](#).



Figure 8. uPyxis® Mobile App installation

## 5.2 Connecting to uPyxis® Mobile App

Connect the ST-500 Series sensor to a mobile smart phone according to the following steps:

1. Open **uPyxis®** Mobile App.
2. On **uPyxis®** Mobile App, pull down to refresh the list of available Pyxis devices.
3. If the connection is successful, the ST-500 Series and its Serial Number (SN) will be displayed (Figure 8).
4. Press on the **ST-500 Series sensor image**.

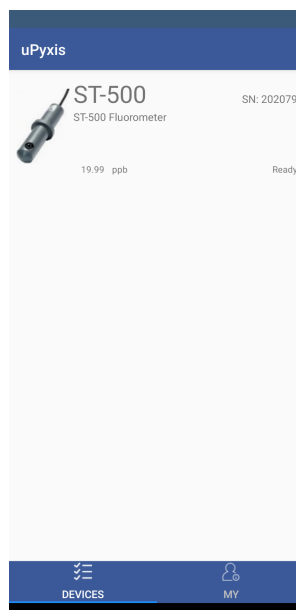

Figure 9.

### 5.3 Calibration Screen and Reading

When connected, the uPyxis® Mobile App will default to the **Calibration** screen. From the **Calibration** screen, you can perform calibrations by pressing on **Zero Calibration**, **Slope Calibration**, and **4-20mA Span**. Follow the screen instructions for each calibration step.

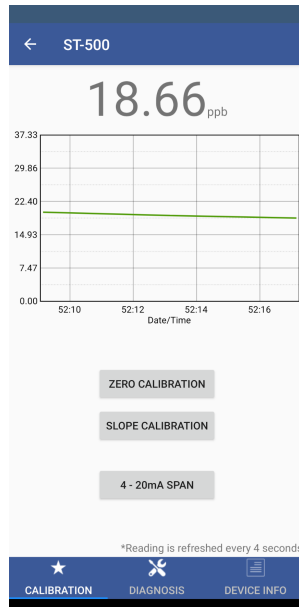

Figure 10.

## 5.4 Diagnosis Screen

From the **Diagnosis** screen, you can check the diagnosis condition as well as **Export & Upload**. This feature may be used for technical support when communicating with [service@pyxis-lab.com](mailto:service@pyxis-lab.com).

To perform a Cleanliness Check, first select the **Diagnosis Condition** which defines the fluid type that the ST-500 Series sensor is currently measuring, then press **Cleanliness Check**. If the sensor is clean, a **Clean** message will be shown. If the sensor is severely fouled, a **Dirty** message will be shown. In this case, follow the procedure in the **Methods to Cleaning the ST-500 Series Sensor** section of this manual.

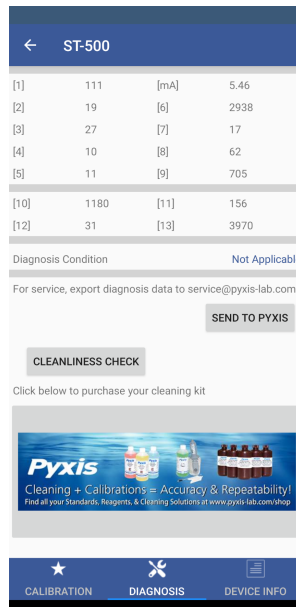

Figure 11.

## 5.5 Device Info Screen

From the **Device Info** screen. You can name the Device or Product.

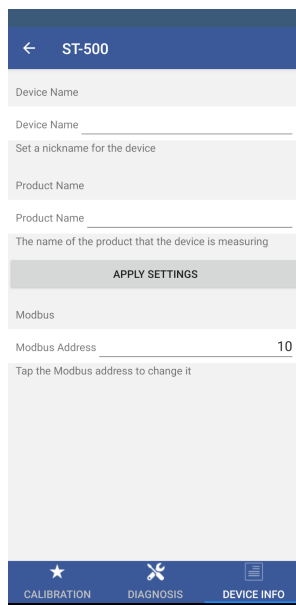

Figure 12.

## 6 Setup and Calibration with uPyxis® Desktop App

### 6.1 Install uPyxis® Desktop App

Download the latest version of uPyxis® Desktop software package from: <https://pyxis-lab.com/upyxis/> this setup package will download and install the Microsoft.Net Framework 4.5 (if not previously installed on the PC), the USB driver for the USB-Bluetooth adapter (MA-NEB), the USB-RS485 adapter (MA-485), and the main uPyxis® Desktop application. Double click the uPyxis.Setup.exe file to install.

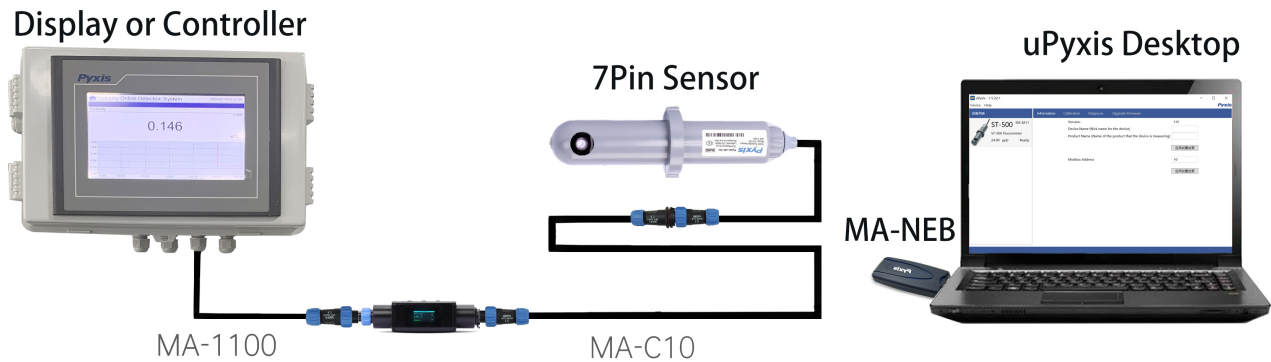

Figure 13. 7-Pin Sensor with MA-WB and MA-NEB and uPyxis Desktop

### 6.2 ConnectWing via USB

A USB-RS485 adapter (P/N: MA-485) can be used to connect a ST-500 Series sensor to a computer with the uPyxis® Desktop App.

**\*NOTE\*** Using non-Pyxis USB-RS485 adapters may result in permanent damage of the ST-500 Series sensor communication hardware.

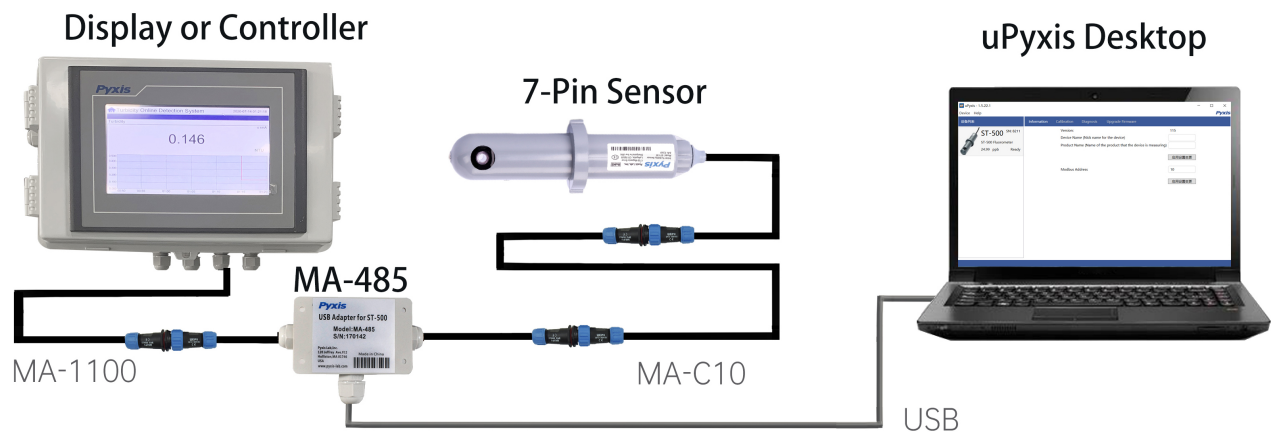
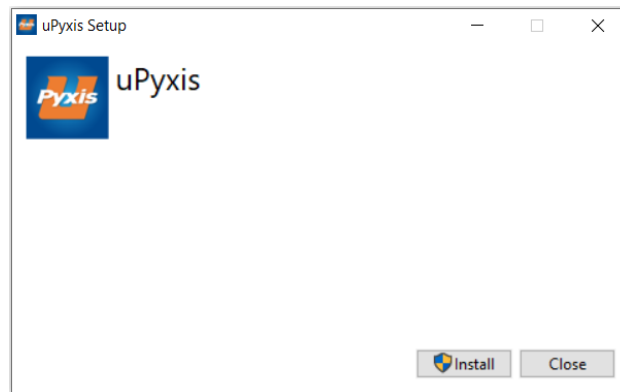

Figure 14. 7-Pin Sensor with MA-485 and uPyxis Desktop



**Figure 15.** uPyxis® Desktop App installation

Click **Install** to start the installation process. Follow the screen instructions to complete the USB driver and uPyxis® installation.

### 6.3 Connecting to uPyxis® Desktop App

Connect the ST-500 Series sensor to a Windows computer using either a Bluetooth/USB adapter (P/N: MA-NEB) or a USB-RS485 adapter (P/N: MA-485) according to the following steps:

1. Plug the Bluetooth/USB adapter or USB-RS485 adapter into a USB port in the computer.
2. Launch uPyxis® Desktop App.
3. On uPyxis® Desktop App, click Device→ **Connect via USB-Bluetooth** or **Connect via USB-RS485** (Figure 14).
4. If the connection is successful, the ST-500 Series and its Serial Number (SN) will be displayed in the left pane of the uPyxis® window.

**\*NOTE\*** After the sensor and Bluetooth is powered up, it may take up to 10 seconds for the adapter to establish the wireless signal for communication.

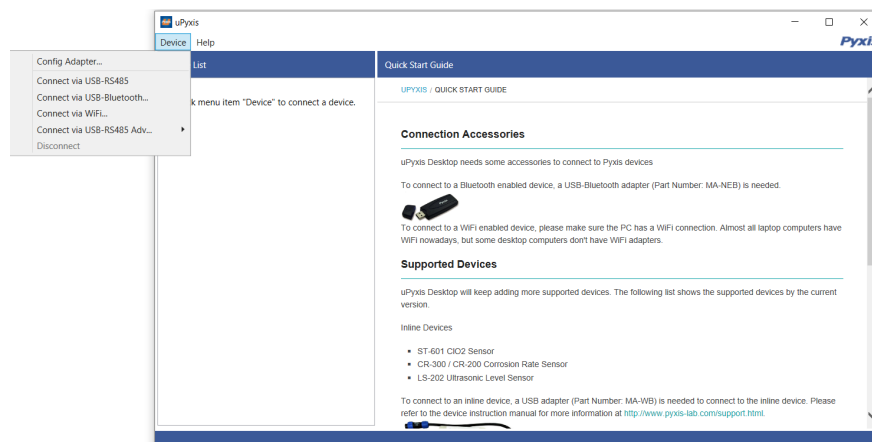

**Figure 16.**

### 6.4 Information Screen

Once connected to the device, a picture of the device will appear on the top-left corner of the window and the uPyxis® Desktop App will default to the **Information** screen. On the **Information** screen you can set the information description for **Device Name**, **Product Name**, and **Modbus Address**, then click **Apply Settings** to save.

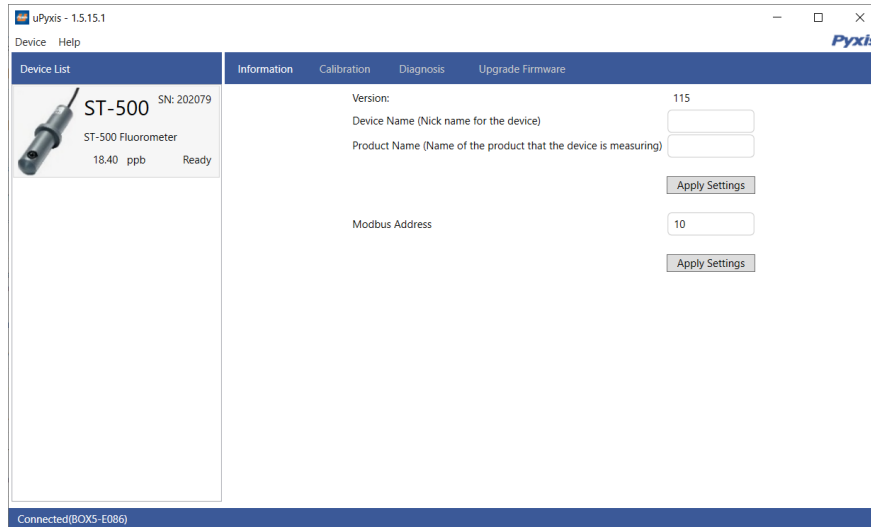

Figure 17.

### 6.5 Calibration Screen

To calibrate the device, click on **Calibration**. On the **Calibration** screen there are three calibration buttons, **Zero Calibration**, **Slope Calibration**, and **4-20mA Span**. The screen also displays the reading of the device. The reading refresh rate is every 4 seconds. Follow the screen instructions for each calibration step.

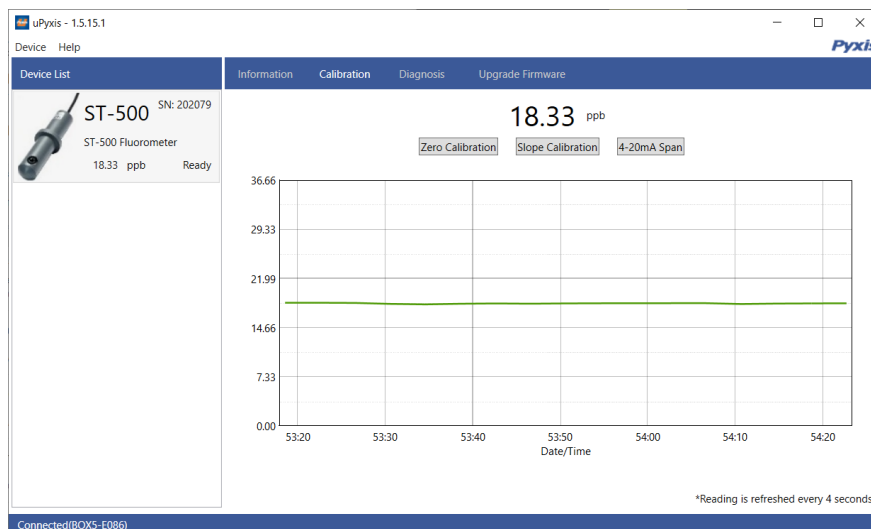

Figure 18.

## 6.6 Diagnosis Screen

After the device has been calibrated and installation has been completed, to check diagnosis, click on **Diagnosis**. When in the **Diagnosis** screen you can view the Diagnosis Condition of the device. This feature may be used for technical support when communicating with [service@pyxis-lab.com](mailto:service@pyxis-lab.com).

To perform a Cleanliness Check, first select the **Diagnosis Condition** which defines the fluid type that the ST-500 Series sensor is currently measuring, then click **Cleanliness Check**. If the sensor is clean, a green **Clean** message will be shown. If the sensor is severely fouled, a red **Dirty** message will be shown. In this case, follow the procedure in the **Methods to Cleaning the ST-500 Series Sensor** section of this manual.

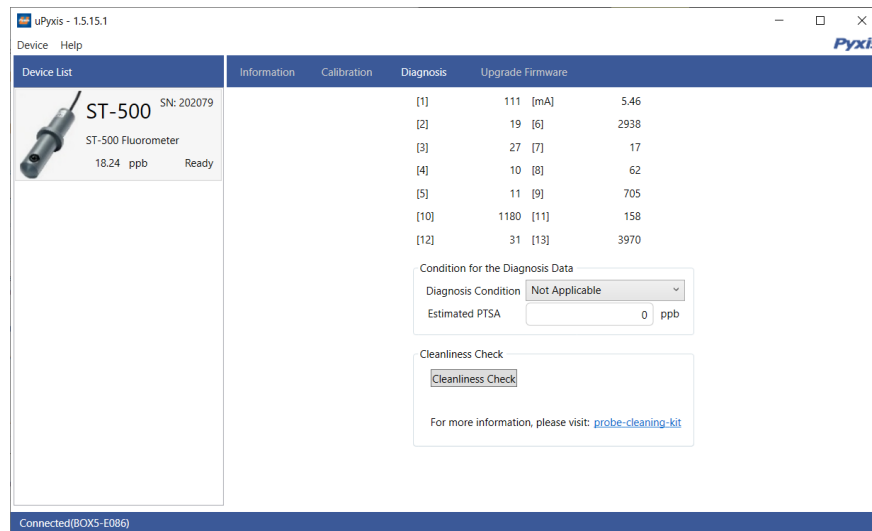

Figure 19.

## 7 Outputs

### 7.1 4–20mA Output Setup

The 4–20mA output of the ST-500 and ST-500SS sensor is scaled as:

- PTSA:
  - 4 mA = 0 ppb
  - 20 mA = 200 ppb

The 4–20mA output of the ST-500RO sensor is scaled as:

- PTSA:
  - 4 mA = 0 ppb
  - 20 mA = 40 ppb

## 7.2 Adjusting 4–20mA Span

Users may adjust the output scale using 4–20mA Span to change the PTSA value corresponding to the 20 mA output via uPyxis®. For the uPyxis® Mobile App, press **4-20mA Span** found on the **Calibration and Reading Screen**, shown in Figure 18. For the uPyxis® Desktop App, click **4-20mA Span** found on the **Calibration Screen**, shown in Figure 19.

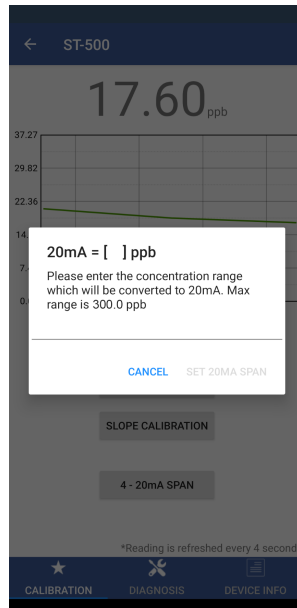

Figure 20.

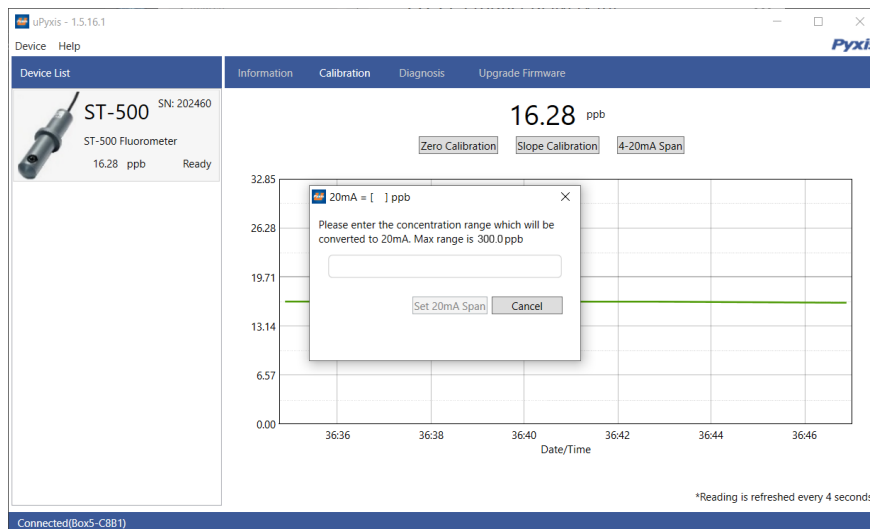

Figure 21.

**\*NOTE\*** Pyxis accommodates custom requests for ST-500/ST-500SS with ranges up to 600.0 ppb.

### 7.3 Communication using Modbus RTU

The ST-500 Series sensor is configured as a Modbus slave device. In addition to the ppb PTSA value, many operational parameters, including warning and error messages, are available via a Modbus RTU connection. Contact Pyxis Lab Customer Service ([service@pyxis-lab.com](mailto:service@pyxis-lab.com)) for more information.

## 8 Sensor Maintenance and Precaution

The ST-500 Series sensor is designed to provide reliable and continuous PTSA readings even when installed in moderately contaminated industrial cooling waters. Although the optics are compensated for the effects of moderate fouling, heavy fouling will prevent the light from reaching the sensor, resulting in low readings and the potential for product overfeed if the ST-500 Series sensor is used as part of an automated control system. When used to control product dosing, it is suggested that the automation system be configured to provide backup to limit potential product overfeed, for example by limiting pump size or duration, or by alarming if the pumping rate exceeds a desired maximum limit.

The ST-500 Series sensor is designed to be easily removed, inspected, and cleaned if required. It is suggested that the ST-500 Series sensor be checked for fouling and cleaned/calibrated on a monthly basis. Heavily contaminated waters may require more frequent cleanings. Cleaner water sources with less contamination may not require cleaning for several months.

The need to clean the ST-500 Series sensor can be determined by the **Cleanliness Check** using either the **uPyxis®** Mobile App (see the **Mobile Diagnosis Screen** section) or the **uPyxis®** Desktop App (see the **Desktop Diagnosis Screen** section).

### 8.1 Methods to Cleaning the ST-500 Series Sensor

Any equipment in contact with industrial cooling systems is subject to many potential foulants and contaminants. Our inline sensor cleaning solutions below have been shown to remove most common foulants and contaminants. A small, soft bristle brush, Q-Tips cotton swab, or soft cloth may be used to safely clean the sensor housing and the quartz optical sensor channel. These components and more come with a Pyxis Lab **Inline Probe Cleaning Solution Kit** (P/N: SER-01) which can be purchased at our online E-Store <https://pyxis-lab.com/product/st-series-probe-cleaning-kit/>



**Figure 22.** Inline Probe Cleaning Solution Kit

To clean the ST-500 Series sensor, soak the lower half of the sensor in 100 mL inline sensor cleaning solution for 30 minutes. Rinse the ST-500 Series sensor with distilled water and then check for the flashing blue light inside the ST-500 Series sensor quartz tube. If the surface is not entirely clean, continue to soak the ST-500 Series sensor for an additional 30 minutes. Use the small, soft bristle brush and Q-Tips cotton swabs as necessary to remove any remaining contaminants in the ST-500 Series sensor quartz tube.

## 8.2 Storage

Avoid long term storage at temperature over 140 °F. In an outdoor installation, properly shield the ST-500 Series sensor from direct sunlight and precipitation.

## 9 Troubleshooting

If the ST-500 Series sensor output signal is not stable and fluctuates significantly, make an additional ground connection — connect the clear (shield, earth ground) wire to a conductor that contacts the sample water electrically such as a metal pipe adjacent to the ST-500 Series tee.

Carry out routine calibration verification against a qualified PTSA standard. After properly cleaning the ST-500 Series sensor, carry out the zero point calibration with distilled water and slope calibration using the qualified PTSA standard. Pyxis Lab **PTSA Standards** can be purchased at our online E-Store <https://pyxis-lab.com/product/ptsa-standards/>



Figure 23. PTSA 100 Standard

## 10 Contact Us

Pyxis Lab, Inc

1729 Majestic Dr. Suite 5

Lafayette, CO 80026 USA

[www.pyxis-lab.com](http://www.pyxis-lab.com)

Phone: +1 (866) 203-8397

Email: [service@pyxis-lab.com](mailto:service@pyxis-lab.com)