



SP-800 Portable Water Analyzer Operation Manual

Rev.B



© Pyxis Lab, Inc 2022
All Rights Reserved

Pyxis Lab, Inc
1729 Majestic Dr Suite 5
Lafayette, CO 80026 USA
www.pyxis-lab.com
service@pyxis-lab.com

Contents

1	General Description	1
1.1	Specification.....	1
1.2	Pyxis Major Features.....	2
1.3	Unpackaging the Instrument	2
1.4	Standard Accessories	2
1.5	Sample Vial Compartment.....	3
1.6	Light Shield Cover	3
2	Start the SP-800	5
2.1	Battery Installation	5
2.1	Description of the Navigational Control Pad	5
2.2	Turning on the SP-800	5
2.3	Main Page	6
2.4	Turning off the SP-800	6
2.5	The SP-800 Auto Power off.....	6
2.6	Auto LCD Power Saving.....	6
3	Colorimetric Measurement.....	7
3.1	Supported Methods.....	7
3.2	Select a Method.....	10
3.3	Single Timing Step Method.....	10
3.4	Single-Vial Procedure.....	11
3.5	Two-Vial Methods.....	11
3.6	Multiple Timing Steps Method	12
3.7	Advanced Methods.....	13
3.7.1	Low range, direct reading chlorine dioxide, 0 to 35.0 ppm	13
3.7.2	Turbidimetric Anionic Polymer Method	13
3.7.3	Direct Reading Bleach Percent Method, 0 to 15%.....	13
3.8	Method Setup and Calibration	14
3.8.1	Set up the method parameters.....	14
3.8.2	Slope Calibration	14
3.8.3	LowC Calibration	15

3.8.4	Resume to Default Calibration Parameters	15
4	Turbidity Measurement	15
4.1	Operation	15
4.2	Turbidity Calibration	16
5	Absorbance Measurement	17
6	Bluetooth Interface	18
6.1	Install Software	18
6.2	Turn on SP-800 Bluetooth	18
6.3	Connect uPyxis to SP-800	19
6.3.1	Upgrade Firmware	19
6.3.2	Add User Defined Colorimetric Methods.....	20
6.3.3	Download Datalog.....	20
7	Maintenance	22
8	Troubleshooting.....	22
9	Appendix A.....	24

Trademarks and Patents

Hach ® is a registered trademark of the Hach Company, Loveland, CO USA

Confidentiality

The information contained in this manual may be confidential and proprietary and is the property of Pyxis Lab. Information disclosed herein shall not be used to manufacture, construct, or otherwise reproduce the goods disclosed herein. The information disclosed herein shall not be disclosed to others or made public in any manner without the express written consent of Pyxis Lab.

Standard Limited Warranty

Pyxis Lab warrants its products for defects in materials and workmanship. Pyxis Lab will, at its option, repair or replace instrument components that prove to be defective with new or remanufactured components (i.e., equivalent to new). The warranty set forth is exclusive and no other warranty, whether written or oral, is expressed or implied.

Warranty Term

The Pyxis warranty term is thirteen (13) months ex-works. In no event shall the standard limited warranty coverage extend beyond thirteen (13) months from original shipment date.

Warranty Service

Damaged or dysfunctional instruments may be returned to Pyxis for repair or replacement. In some instances, replacement instruments may be available for short duration loan or lease.

Pyxis warrants that any labor services provided shall conform to the reasonable standards of technical competency and performance effective at the time of delivery. All service interventions are to be reviewed and authorized as correct and complete at the completion of the service by a customer representative or designate. Pyxis warrants these services for 30 days after the authorization and will correct any qualifying deficiency in labor provided that the labor service deficiency is exactly related to the originating event. No other remedy, other than the provision of labor services, may be applicable.

Repair components (parts and materials), but not consumables, provided in the course of a repair, or purchased individually, are warranted for 90 days ex-works for materials and workmanship. In no event will the incorporation of a warranted repair component into an instrument extend the whole instrument's warranty beyond its original term.

Shipping

A Repair Authorization Number (RA) must be obtained from the Technical Support (service@pyxis-lab.com) before any product can be returned to the factory. Pyxis will pay freight charges to ship replacement or repaired products to the customer. The customer shall pay freight charges for returning products to Pyxis. Any product returned to the factory without an RA number will be returned to the customer.

1 General Description

1.1 Specification

- Colorimeter Wavelength: 365/420/455/525/560/570/630 nm
- Turbidity Excitation Wavelength: White/infrared LED/90-degree scattering
- Wavelength Accuracy: ± 1 nm
- Absorbance Reproducibility: 0.005 au (0 - 1.0 au) (3sigma)
- Absorbance Linearity Range: 0 to 1.0 au
- Turbidity Reproducibility: 1 NTU (3 sigma)
- Turbidity Detection Limit: 1 NTU
- Turbidity Range: 0 - 200 NTU
- Battery: 4 AA alkaline
- Typical Battery Life: 3 months
- Display: Graphical LCD 160x240 pixels, visible under direct sunlight
- Instrument Dimension: L 265mm W 88mm H 62mm
- Instrument Weight: 600 g without batteries
- Storage Temperature Range: 0 to 140°F (-18 - 60°C)
- Operation Temperature Range: 40 to 120 °F (4 - 49°C)
- Humidity: 85% at 106 °F (41 °C)
- Environmental: IP67, dustproof and waterproof

Note:

1. Specifications are subject to change without notice with Pyxis' continuous development.

1.2 Pyxis Major Features

The SP-800 analyzer shown in Figure 1 is a combination of photometer and turbidimeter. It provides colorimetric measurements at 7 LED wavelengths and nephelometric turbidity measurement using white LED and infrared LED as the excitation sources. The SP-800 is pre-calibrated for colorimetric measurements of analyses common in industrial water treatment and other water testing in the laboratory or in the field, such as chlorine, phosphate, iron, and copper. Main features include:

- The SP-800 is pre-calibrated for measuring turbidity in the range of 0 to 200 NTU.
- Automatically select the primary wavelength according to the method selected and switches to the secondary wavelength to extend the primary measurement range.

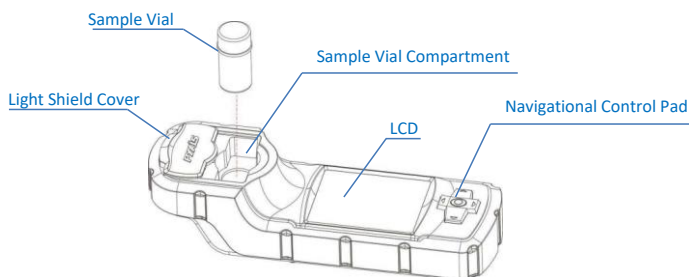

Figure 1. Sample Vial and Major Components

- Display a concentration-time profile curve during the last time period in a colorimetric measurement. The user can terminate the timing process and take a reading if the displayed concentration reaches a plateau before completing the predefined time period.
- The user can update the calibration parameter of any pre-calibrated colorimetric method by testing a standard solution first and then following a setup procedure to update the calibration parameters.
- Built-in Bluetooth allows easy connection to PC or mobile apps for downloading datalog and adding new colorimetric methods.

1.3 Unpackaging the Instrument

Remove the instrument and accessories from the shipping container and inspect each item for any damage that may have occurred during shipping. Verify that all items listed on the packing slip are included. If any items are missing or damaged, please contact Pyxis Customer Service at service@pyxis-lab.com.

1.4 Standard Accessories

- Sample Vials - two 10 ml (Part # MA-24), round, 0.78 inch (20 mm) pathlength, glass vials, which can be used for all measurements including turbidity and fluorescence measurements.
- 4 AA alkaline batteries
- Instrument Manual, also available from www.pyxis-lab.com
- 25 ml sample via (Part # MA-25)
- 16 mm tube adapter (Part # 52214)

Commented [LR1]: 还有两个 25ml 的瓶子也是标配 MA-25 COD 适配器也是标配
 ●25 ml sample via (Part # MA-25)
 ●16 mm tube adapter (Part # 52214)

- Bluetooth/USB Adapter for Desktop (Part # MA-NEB)

1.5 Sample Vial Compartment

The sample vial compartment is shown in Figure 1 along with a 10-ml sample vial. When the sample vial is inserted into the sample vial compartment, the triangular mark on the sample vial should be aligned approximately with the 6 o'clock position of the sample vial compartment or any position consistently.

The sample vial compartment can take in a 25 ml sample vial. The light shield cover is not required to be closed if the 25 ml sample vial is used.

The 16 mm tube adapter is needed for colorimetric methods using the 16 mm sample tube, as shown in Figure 2.

The sample vial compartment should be kept clean. A small amount foreign material could significantly affect turbidity and fluorescence measurement results. Use a soft cloth or lint free paper tissue to clean sample vial compartment periodically. Remove debris, scale, and deposit promptly.



Figure 2 16 mm adapter

1.6 Light Shield Cover

The light shield cover is shown in Figure 3. The light shield cover can be conveniently slid between the open and closed positions. The light shield cover is held firmly at the rest positions by permanent magnets.

The light shield cover should be in the closed position during storage, transportation, and measurements, especially during the turbidity and fluorescence measurements. When turned on, the SP-800 carries out self-diagnosis including checking the performance of a variety of optical devices. The light shield door shall be at the closed position to shield interference from ambient light during self-diagnosis.

Care should be taken to avoid water or debris being trapped in the track of the light shield door.

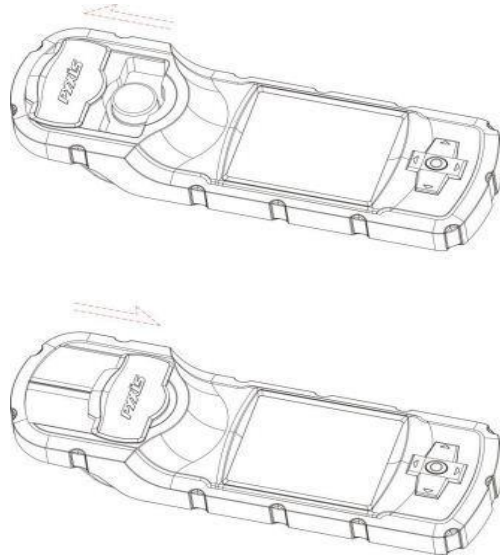

Figure 3 Open and Close the Light Shield Cover

Warning

Magnetic sensitive devices, including but not limited to, credit cards, watches, hard disks, should be keep at a distance of at least 2 inches from the Light Shield Door to avoid possible damage and/or loss of information recorded.

2 Start the SP-800

2.1. Battery Installation

The SP-800 is powered by four AA-size alkaline batteries. Do not use rechargeable nickel cadmium (NiCad) batteries or any AA-size lithium batteries. A set of batteries typically lasts for three months. When the batteries capacity is low, the SP-800 will prompt a LOW BATTERY warning. Replace all four batteries to resume operation of the SP-800 after the battery warning.

The SP-800 battery compartment, shown in Figure 4, is on the back side of the instrument. Insert a small pad underneath the screen area to make the back-surface level when the instrument is turned upside down. Install batteries as followings:

1. Remove the battery compartment cover by loosening four screws.
2. Insert four batteries into the battery holder as shown in Figure 4. Make sure the positive battery polarity marker (+) is aligned with the positive marker (+) on the battery holder.
3. Replace the battery compartment cover, making sure that the sealing O-ring is lying flat on the battery holder and tighten the four screws.

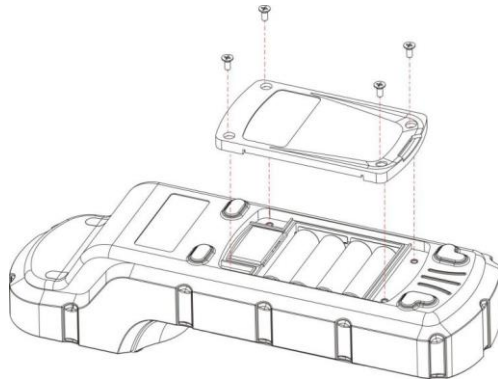

Figure 4 Replace Batteries

2.1 Description of the Navigational Control Pad

The SP-800 navigational control pad consists of five keys as shown in Figure 1. The left, right, up, and down keys are navigational keys that are used to select an icon, a button, or other items in various pages. The center key is the OK key. Press the OK key on a selected item to launch the action associated with the selected item. The OK key is also used to accept the current selection, like the return key in a computer keyboard.

2.2 Turning on the SP-800

After new batteries installation, the SP-800 will not be automatically turned on. To turn on SP-800, press the OK key, and release the OK key when the LCD is lit.

You can navigate the main page menu and launch an operation by pressing on an icon. If battery voltage is too low for the instrument to work properly, the SP-800 will show a low battery warning message when it is being turned on. If this happens, replace all four batteries.

2.3 Main Page

The SP-800 provides intuitive icon driven user operations. On the main page, six major feature groups are illustrated as below:

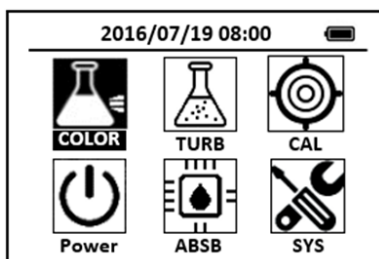

Figure 5. Main Menu

A brief description of each feature group is given in Table 1. Detailed operation instructions can be found in the following chapters.

Table 1 Feature Groups on Main Menu

No.	Title	Description
1	COLOR	Colorimetric measurement methods
2	TURB	Turbidity measurement
3	Power	Turn off SP-800
4	ABSB	Absorbance measurements
5	CAL	Calibration routines
6	SYS	System and diagnosis information, Bluetooth enabling

2.4 Turning off the SP-800

Turn the SP-800 off by navigating to Power icon and press the OK key. Alternatively, you can turn off the SP-800 by pressing OK key for 5 seconds in any menu.

2.5 The SP-800 Auto Power off

The SP-800 automatically turns itself off with no-key activity for a given period, except for during a measurement. The auto power-off time can be set in **SYS->System Set**. Pressing OK key will wake up the instrument, and the SP-800 will return to the original page if it has any measurement data.

2.6 Auto LCD Power Saving

During a colorimetric method measurement, The SP-800 automatically turns LCD backlight off with no-key activity and continues the measurement with the LCD backlight off. The auto LCD power-off time can be

set in **SYS->System Set**. Pressing any key will turn on the LCD backlight. Under normal ambient lighting condition, icons and other contents shown on the LCD screen are readable without backlight being on.

3 Colorimetric Measurement

3.1 Supported Methods

A wide range of colorimetric methods is supported by the SP-800 analyzer and the number of them keeps increasing with continuous development of Pyxis. See corresponding Hach® methods in Appendix A.

Table 2 List of Supported Colorimetric Methods

Abbreviated Method Name	Method Name	Description	Range
AL	Alumi	Aluminum,Aluminon method	0.8 ppm
ALKLR	Alkalinity	Alkalinity, Total, Low Range	100 ppm as CaCO3
ALKHR	Alkalinity	Alkalinity, Total, High Range	500 ppm as CaCO3
AZOL	Azole	UV digestion for tolyltriazone and benzotriazole	16 ppm
BLCH	Bleach	Direct method measuring sodium hypochlorite concentration	16%
BLCHL	Bleach	Direct method measuring sodium hypochlorite concentration, Low Range	1.50%
Br-T	Bromine	Bromine,DPD method for	4.5 ppm
Ca	Ca	Calcium ,Calmagite method	4 ppm as CaCO3
CaHR	Ca	Calcium hardness ,Murexide method	500 ppm as CaCO3
CaMgL	CaMg	Total hardness,Chlorophosponazo colorimetric method , Ultra-Low Range	1 ppm as CaCO3
CODLR	COD	Oxygen Demand, Chemical (Reactor Digestion 20 Minutes Method) ,Low range	150 ppm
CODHR	COD	Oxygen Demand, Chemical (Reactor Digestion 20 Minutes Method) , High range	1500 ppm
CODUH	COD	Oxygen Demand, Chemical (Reactor Digestion 20 Minutes Method) ,Ultra-High Range	15000 ppm
CODUL	COD	Oxygen Demand, Chemical (Reactor Digestion 20 Minutes Method) ,Ultra-Low Range	40 ppm
CLLR	CLLR	Turbidimetric method,Low Range	40 ppm
CLMR	CLMR	Turbidimetric method ,Medium Range	400 ppm
CL2HR	CL2High	Total Chlorine, DPD method , High Range	10 ppm
CL2HR	CL2High	Free Chlorine, DPD method , High Range	10 ppm
CL2UH	CL2UH	Free Chlorine, Iodimetr method ,Ultra-High Range	400 ppm
CL-F	F-Chlorine	Free chlorine, DPD method	2.2 ppm
CLTMB	Chlorine, Free	Free chlorine ,TMB method	1.2 ppm

Commented [LR2]: 这一部分要根据最近发布的 SP-800 操作手册进行更新

Abbreviated Method Name	Method Name	Description	Range
CIO2	CIO2-DPD	DPD method, USEPA accepted for reporting drinking water analysis	5 ppm
CIO2D	CIO2Direct	Direct method for chlorine dioxide,Medium Range	45 ppm
CLO2H	CIO2Direct	Direct method for chlorine dioxid, High Range	1500 ppm
CL-T	T-Chlorine	Total chlorine, DPD method	2.2 ppm
CN	Cyanide	Cyanide,Pyridine-Pyrazalone method	0.24 ppm
COLOR	Color	Color, APHA Platinum-Cobalt Standard Method	500 units
Cr6	Cr6	chromium hexavalent,1,5-Diphenylcarbohydrazide method , USEPA accepted for wastewater analyses	0.6 ppm
CrT	CrTot	Total Chromium ,Alkaline hypobromite Oxidation method	0.6 ppm
CuBi	Cu_Bicinch	Bicinchoninate method, EPA approved for reporting wastewater analysis	5 ppm
CuLR	CuPorp	Copper,Porphyrin method	0.21 ppm
CYAN	CYAN	Cyanuric acid,Turbidimetric method	55 ppm
CYN-F	Cyclohexylamine	Cyclohexylamine,Fluorescent method	1.2 ppm
DEHA	DEHA	Iron Reduction method for N,N-diethylhydroxylamine and other oxygen scavengers	0.5 ppm
DO	DO	Dissolved Oxygen,Iodimetry method	10 ppm
F	Floride	Fluoride, SPADNS method	2 ppm
FeMo	FeMo	Total iron method for water containing molybdate	1.8 ppm
FePh	Fe_phenanth	Total iron using 1,10-phenanthroline, USEPA approved for reporting wasterwater analysis	3 ppm
FeSal	Fe-Sal	Total Iron using 5-Sulfosalicylic Acid Dihydrate	5 ppm
FeTp	FeTptz	Total iron using TPTZ	1.8 ppm
FeZi	FeZine	Total iron , FerroZine method	1.3 ppm
H2O2	H2O2	Hydrogen peroxide,Iodimetry method	500 ppm
H2O2L	H2O2L	Hydrogen peroxide, DPD method,Low Range	1.5 ppm
Mg	Mg	Magnesium,Calmagite method	4 ppm as CaCO3
MnHR	MnHigh	Manganese,Periodate Oxidation method,High range	20 ppm
MnLR	MnLow	Manganese,Periodate Oxidation method,Low range	0.7 ppm
MoHR	Mo_HighRange	Molybdate, Mercaptoacetic Acid method,High range	40 ppm
MoLR	Mo_LowRange	Molybdate, ternary complex method,Low range	3 ppm
N2H4	N2H4	Hydrazine,p-Dimethylaminobenzaldehyde method	0.5 ppm
NH2C	NH2CL	Chloramine mono ,Indophenol method	3 ppm
N-TLR	N-TLR	Nitrogen, Total (Test 'N Tube Method) ,Low range	25 ppm as N

Abbreviated Method Name	Method Name	Description	Range
N-THR	N-TLR	Nitrogen, Total (Test 'N Tube Method) ,High range	150 ppm as N
NH3S	NH3Sal	nitrogen, ammonia ,Salicylate method	0.5 ppm as N
NH3-F	NH3-F	Ammonia Nitrogen ,Fluorescent Method	0.07 ppm as N
NH3LR	NH3LR	Nitrogen, Ammonia (Test 'N Tube) - Low range	2.5 ppm as N
NH3HR	NH3HR	Nitrogen, Ammonia (Test 'N Tube) -High range	50 ppm as N
Ni	Ni	Nickel,PAN method	1.2 ppm
NO2D	NO2D	Direct method for nitrite	1000 as NO2
NO2H	NO2H	High range nitrite, ferrous sulfate method	150 as NO2
NO2L	NO2L	Low range nitrite, diazotization method, USEPA approved for reporting wastewater and drinking water analysis	0.35ppm as NO2
NO3HR	NO3H	Nitrate ,Cadmium Reduction method,High range	30 ppm as N
NO3MR	NO3M	Nitrate ,Cadmium Reduction method,Middle range	5 ppm as N
NO3CA	NO3CA	Nitrate, High Range (Test 'N Tube Method)	30 ppm as N
O3	O3	Ozone ,DPD method	2 ppm
PAA	PAA	Peroxyacetic , Iodimetry method	500 ppm
OPO4	OPO4	Reactive phosphate using ascorbic acid molybdenum blue method, USEPA accepted for wastewater analysis	2.5 as PO4
OrgP	Phosphonate	UV digestion and ascorbic acid reduction molybdenum blue method	2.5 as PO4
PAmi	OPO4-Amino	Reactive phosphate, amino acid reduction method	30 as PO4
P-TLR	P-TLR	Phosphorus, Total (Test 'N Tube Method) - Low range	3.5 as PO4
P-THR	P-THR	Phosphorus, Total (Test 'N Tube Method) - High range	100 as PO4
pH	pH	Phenol red method for pH	8.5
PMoV	OPO4-MoV	Reactive phosphate , Molybdovanadate method	45 as PO4
POLY	Polymer	Anionic polymeric dispersant,Turbidimetric method	14 ppm
Sb3+	Sb3+	Antimony Trivalent ,PADAP Method	0.11 ppm
Sb-T	Sb-T	Antimony, Total ,PADAP Method	0.11 ppm
S2-	Sulfide	Methylene blue method for sulfide, USEPA accepted for reporting wastewater analysis	0.7 ppm
SiHR	SiHR	Silica, Silicomolybdate method,High Range	75 as SiO2
SiLR	SiLR	Silica,Heteropoly Blue method,Low Range	5 as SiO2
SO3LR	SO3LR	Sulfite,OPA method ,Low Range	5 ppm
SO3HR	SO3HR	Sulfite,OPA method , High Range	50 ppm
SO4	SO4	Barium sulfate, Turbidimetric method	70 ppm
TOC	TOC	Total Organic Carbon	20 ppm

Abbreviated Method Name	Method Name	Description	Range
Urea	Urea	Urea (Reactor Digestion Method)	10 ppm
ZnXO	ZnXO	Zinc ,Xylenol orange method	3 ppm
Zn	Zinc	Zincon method for zinc, USEPA approved for wastewater analysis	3 ppm

3.2 Select a Method

Move the icon focus to the method icon **COLOR** using the navigational (left, right, up, or down) keys. Press OK on the icon to launch the first method selection page. The methods shown on the top row of the page are the most frequently selected methods.

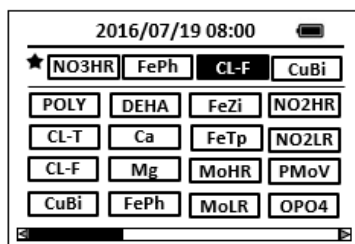

Figure 6 Method Selection

The followings are the operations associated with this page:

1. Use the navigational keys and the OK key to select and launch a method.
2. Long press the OK key to return to the main page. Press the arrow icon at the lower right corner of the page to display the second method selection page if the device is loaded with more than 80 methods.

Note: Methods shown in the method selection pages include Hach© equivalent methods and Pyxis specific advanced methods. The table in Appendix A provides a brief description of Pyxis method names and their corresponding Hach© program number. Hach© reagents for 10 ml sample can be used for the test.

3.3 Single Timing Step Method

Most of colorimetric methods have only one timing step. As an example, in the DPD free chlorine method, it takes one minute for the DPD powder reagent to completely react with chlorine in the water sample. The DPD free chlorine method has a single one-minute timing step. Figure 7 shows the main page of a method with a single timing step.

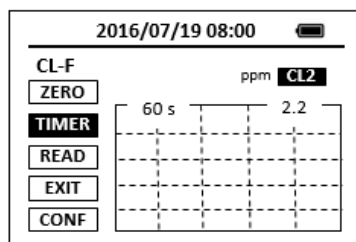

Figure 7. Single Timer Method

3.4 Single-Vial Procedure

1. Place the sample vial filled with the water sample in the SP-800 sample vial compartment and press the **ZERO** button. The SP-800 will display the page shown in Figure 7.
2. Take the sample vial out and add the reagent to the sample vial.
3. Place sample vial back into the sample vial compartment and press the timer button **TMR1**. The SP-800 will start to monitor the reaction between the reagent and the species you want to measure in the water sample. The concentration is shown in the chart as a function of time (Figure 8).
4. When the timer reaches the preset time and the reaction is complete, the value of concentration will be shown on the top right corner of the page.
5. The rate of the reaction is often faster than the standard pre-set time, which will become apparent from the concentration-time plot. You can press the **STOP** button to stop the timer and terminate the timing step. The last read concentration value will be displayed on the top right corner of the page after you terminate the timing step.

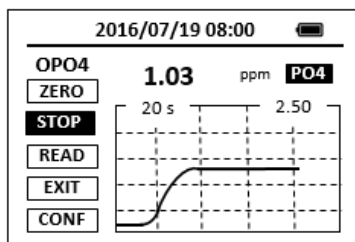

Figure 8. Concentration as a Function of Time

3.5 Two-Vial Methods

Some colorimetric methods require using two vials. The water sample is added to two identical vials. One vial is being used to zero the colorimeter, referred as to the prepared blank. A reagent is added to the other vial, referred as to the prepared sample. The absorbance value is determined from the prepared sample.

If the method requires two or more reagents, the prepared blank could be the resulting solution after one or more reagents have been added to the sample.

The following procedure is typical for two-vial methods:

1. Place the prepared blank into the SP-800 sample vial compartment and press the **ZERO** button to zero the instrument.

2. Place the prepared sample into the SP-800 sample vial compartment and press the **TMR1** button to start the method timer.
3. When the timing step is completed, the measured concentration will be displayed on the top of the page. The timing step could be terminated earlier by pressing **STOP** button.
4. Optionally, the SP-800 can be re-zeroed using the prepared blank after the timing step is completed or terminated. The blank reading will be subtracted from the measured concentration value, and the displayed concentration value on the top-right corner will be updated. This step is optional. It is only necessary if the prepared blank changes its color during the timing period.
5. Optionally, the prepared sample vial can be put back and read again by pressing the **READ** button if the blank is re-zeroed after the timing step is completed or terminated. A new concentration value based on the last absorbance value measured will be calculated and displayed.

3.6 Multiple Timing Steps Method

Some colorimetric methods have two or three timing steps. The SP-800 shows a count-down timer for the timing steps before the last timing step (Figure 9). During these timing steps, one or more reagents are added to the sample, or operations such as swirling the vial to mix the reagent and the sample are being performed. These methods usually use one vial for the prepared blank and the other for the prepared sample.

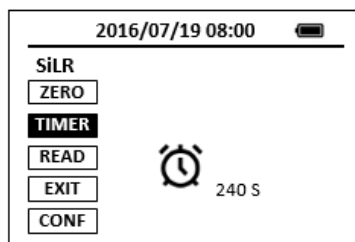

Figure 9. Multiple Timer Method

In order to show the concentration-time curve as shown in Figure 8 during the last timing step, The SP-800 must be zeroed using the prepared blank before the last timing step. Thus, the last timer button will not be selectable until the SP-800 has been zeroed using the prepared blank. Multi-timing step Hach® methods require zeroing the colorimeter using the prepared blank after the last timing step is completed. The SP-800 can optionally be re-zeroed using the prepared blank after the last timing step. The blank value measured will be subtracted from the concentration value measured at the end of the last timing step. Optionally, the **READ** button could be pressed to read the prepared sample again.

The following procedure is typical for methods having two-timing steps:

1. Press the **TMR1** button to start the first timer. Complete the necessary operations to prepare the blank and the sample.
2. Place the prepared blank into the SP-800 sample vial compartment and press the **ZERO** button.
3. Place the prepared sample into the SP-800 sample vial compartment and press the **TMR2** button to start the second timer. The SP-800 will display the measured concentration as a function of time as shown in Figure 8.

4. When the timing step is completed, the measured concentration will be displayed on the top right of the screen. The timing step could be terminated earlier by pressing **STOP** button.
5. Optionally, The SP-800 can be re-zeroed using the prepared blank after the timing step is completed or terminated. The blank reading will be subtracted from the measured concentration value, and the displayed concentration value on the top-right corner will be updated. This step is optional. It is only necessary if the prepared blank changes its color during the timing period.

3.7 Advanced Methods

The SP-800 provides 7 LED wavelengths and can measure absorbance values at multiple LED wavelengths. Consequently, the SP-800 can provide many predefined advanced methods that traditionally require complex and often expensive lab testing procedures.

3.7.1 Low range, direct reading chlorine dioxide, 0 to 35.0 ppm

The maximum absorption bank of aqueous chlorine dioxide is around 360nm. The SP-800 has a 365nm UV LED and can be used to directly measure chlorine dioxide. It offers a much lower detection limit (0.2 ppm) than direct methods available from other portable colorimeters having only light sources in the visible range.

Select **CIO2D** in the method selection page and carry out the following steps to measure chlorine dioxide:

1. Place a vial filled with deionized water into the vial compartment and press the **ZERO** button to zero the SP-800.
2. Discard the deionized water and fill the same vial with the sample. Place the vial into the vial compartment and press **READ** button to read. The measured chlorine dioxide concentration will be displayed in the top of the method page.

3.7.2 Turbidimetric Anionic Polymer Method

1. Add polymer reagent 1 to 10 ml sample and inverse the sample vial 5 times to mix the reagent with the sample. Place the sample via to the sample vial compartment.
2. Press on **ZERO**.
3. Add polymer reagent 2 and press on **TMR1** to start the five minutes timer.
4. Gently inverse the sample via for 10 times and place the sample vial to the sample vial compartment.
5. Polymer concentration will be measured and displayed when the five-minute timer is reached. The polymer concentration is shown as ppm PAA (polyacrylic acid) equivalent.

3.7.3 Direct Reading Bleach Percent Method, 0 to 15%

The SP-800 has a 365nm UV LED and other deep blue LEDs that can be used to directly measure bleach concentration in the range of 0 to 15%. No reagent is required for the method and the displayed result is the sodium hypochlorite concentration in percentage.

Select **BLCH** in the method selection page and carry out the following steps:

1. Press the OK key to enter the temperature input interface. Enter the temperature of the sample.

Commented [LR3]: 目前有温度补偿关于漂水测试，要更新这部分内容

2. Place a vial filled with deionized water into the vial compartment and press the **ZERO** button to zero the SP-800.
3. Discard the deionized water and fill the same vial with the bleach sample. Place the vial into the vial compartment and press **READ** button to read. The measured bleach concentration will be displayed in the top of the method page.

3.8 Method Setup and Calibration

Press the **SETUP** button in the method result page to launch the method setup and calibration page.

3.8.1 Set up the method parameters

Press the **FORM** button to select a concentration form from the list of forms that are available for this specific method (Figure 10).

Press the **UNIT** button to select a concentration unit among the list of ppb, ppm, mg/L, ug/L and No Unit (Figure 11).

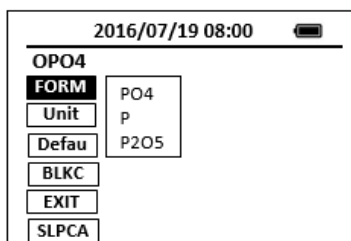

Figure 10. Method form Selection

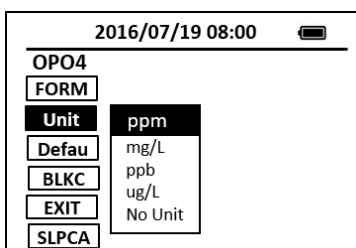

Figure 11. Method Unit Selection

3.8.2 Slope Calibration

If the method has been calibrated prior to shipping, there is no need to calibrate unless a calibration check indicates that the method needs a calibration. The following steps are used to calibrate a method:

1. Use a calibration standard of known concentration. Follow the steps required by the method and note the value reported by the SP-800.

2. If the measured value differs from the known standard value, Press the **CONFIG** button to launch the method configuration page.
3. Press the slope calibration button **SlpCal**. A numeric keyboard will be displayed.
4. Enter the concentration value and press the OK key on the enter key in the numeric keyboard to return to the configuration page.
5. Press the **EXIT** button. Press the OK key to accept the calibration or other key to cancel the calibration.

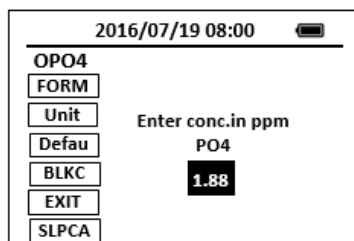

Figure 12. Slope Calibration

For best results, the concentration of the standard solution should be less than the maximum concentration for the method (Table 2) and greater than the half of the maximum concentration. For example, to calibrate total chlorine, the chlorine concentration in the standard solution should be between 1.1 and 2.2 ppm.

The corresponding calibration parameters will be updated and saved in the memory as the working calibration parameter set. Note that this set of calibration parameters are not the same as the default set. You can use **Default** button to copy the default calibration parameters to the working set.

3.8.3 LowC Calibration

Some methods have a non-zero intercept value in the calibration equation. For these methods, a proper non-zero intercept value is pre-loaded in the SP-800 prior to shipping. The following steps are used to carry out a reagent blank calibration:

1. Follow the normal steps to carry out a measurement on a deionized water sample.
2. Press the **CONFIG** button to launch the method configuration page.
3. Press the LowC calibration button **LowC**
4. Press the OK key to save when exiting from the configuration page or press other keys to cancel.

3.8.4 Resume to Default Calibration Parameters

Pressing the **Default** button will copy the default calibration intercept and slope to the working intercept and slope, respectively. If the default calibration parameters were created prior to shipping, this button action is to restore the working calibration parameters to the original factory loaded calibration parameters.

4 Turbidity Measurement

4.1 Operation

Commented [LR4]: 目前已修改为 LowC 低点校准

Follow the following steps to measure turbidity:

1. Fill the 10 ml sample vial to above the 10 ml mark.
2. Insert the sample vial to the sample vial compartment.
3. Slide the light shield cover to the closed position.
4. Press the **TURB** on the main page, then press the **OK** key, The SP-800 will start to measure the turbidity in the sample.

4.2 Turbidity Calibration

1. Fill the 10 ml sample vial to above 10 ml mark with the deionized water.
2. Insert the sample vial to the sample vial compartment.
3. Slide the light shield cover to the closed position.
4. Press the **CAL** on the main page, then choose the Turbidity calibration and press the **OK** button to launch the Turbidity calibration page. (Figure 13)
5. Press the **OK** key to measure the deionized water
6. Fill the 10 ml sample vial to above 10 ml mark with the 50 NTU standard. Insert the sample vial to the sample vial compartment.
7. Press the **OK** key to measure the 50 NTU standard. Low range turbidity calibration is successful
8. Press the **OK** key to continue high range turbidity calibration. If high range turbidity calibration not required, press any keys to exit. (Figure 14)
9. Fill the 10 ml sample vial to above 10 ml mark with the 100 or 200 NTU standard. Insert the sample vial to the sample vial compartment.
10. Follow the message prompts, use the upper or down key to switch the standard between 100 NTU and 200 NTU.
11. Press the **OK** key to measure the selected standard. High range turbidity calibration is successful. (Figure 15)
12. Press any keys to exit.

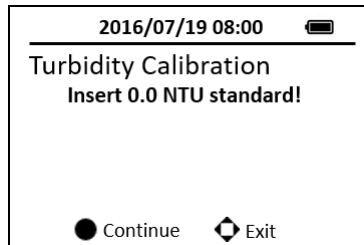

Figure 13. Turbidity Calibration-1

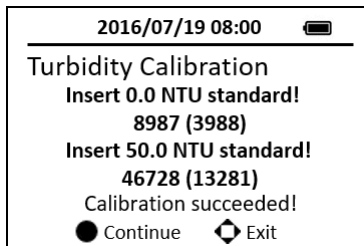

Figure 14. Turbidity Calibration-2

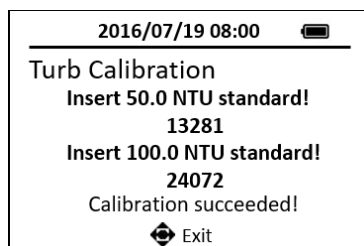

Figure 15. High Range Turbidity Calibration

5 Absorbance Measurement

The following steps are used to measure the absorbance values of a sample:

1. Press the **ABS** to launch the absorbance measurement page.
2. Place a vial filled with the blank sample in the sample vial compartment. Press the **ZERO** button to zero the method.
3. Place a vial filled with the sample in the sample vial compartment. Press the **READ** button to read absorbance. The absorbance values of first 6 wavelengths (Table 3) will be shown. Press the **READ** button again to show the absorbance values of the last three wavelengths.

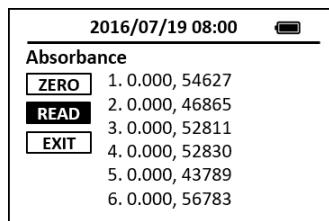

Figure 16. Absorbance Measurement

Press **EXIT** to return to the main page. Timing function for absorbance measurement may not be available for some models.

Table 3 Wavelength of each channel

Channel	Wavelength (nm)
1	560
2	570
3	Not used
4	Not used
5	455
6	525
7	365
8	630
9	420

Note that the absorbance values measured with the SP-800 is generally smaller than those measured with a spectrophotometer equipped with a monochromatic light source or detector. The SP-800 absorbance values should, however, linearly correlate with the absorbance values measured with the spectrophotometer. Thus, for any colorimetric system, The SP-800 absorbance follows Lambert-Beer law.

6 Bluetooth Interface

The SP-800 equipped with a Bluetooth interface, which allows a user to connect to SP-800 with a computer or a mobile device to do the following tasks:

- Configure device
- Add user defined colorimetric methods
- Upgrade device firmware
- Download saved datalog

With the Bluetooth interface, the user can calibrate an inline fluorometer directly from SP-800 in the field. Below sections describe how to connect and communicate with your SP-800 via a computer and uPyxis apps.

6.1 Install Software

Download uPyxis software from www.pyxis-lab-lab/supports/, unzip and install uPyxis, The Bluetooth adapter driver will be installed as well. Plug in the Bluetooth adapter shipped along with your SP-800 device, open uPyxis app.

6.2 Turn on SP-800 Bluetooth

The SP-800 Bluetooth function is normally switched off in order to reduce power consumption, to turn on Bluetooth, select SYS in the main menu and click BTLE in the SYS screen.

6.3 Connect uPyxis to SP-800

Click **Device** tap on the top right of uPyxis app. Select UBS-Bluetooth in the dropdown menu. uPyxis will scan nearby Pyxis Bluetooth devices including SP-800 units. Click the discovered SP-800 to connect. If the SP-800 is being automatically powered off during connection, please push the OK key to power on the SP-800 again. The SP-800 will automatically turn on the Bluetooth and repeat the connection steps again in uPyxis.

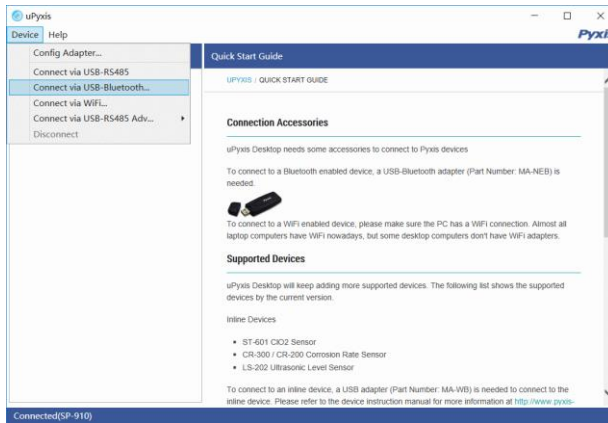

Figure 17. uPyxis Scans Bluetooth Devices

6.3.1 Upgrade Firmware

When connected, click **System** tap to view the device information. The user can upgrade the SP-800 firmware to the latest. The latest version of the SP-800 firmware can be obtained from service@pyxis-lab.com

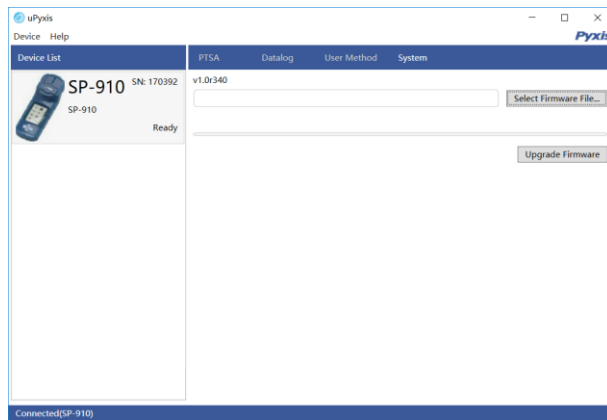

Figure 18. System Information

6.3.2 Add User Defined Colorimetric Methods

Click **User Method** tap and click **Read from Device** to read all current default or user defined methods into uPyxis. Select a method and clone a new method from the selected. The parameters in the method can be edited and are defined as:

No.: a sequence number, the user does not need to enter

Name: the method name

LED: the LED wavelength in nm and can be selected from the dropdown menu.

T1: the first reaction period of the method

T2: the second period of the method

T3: the third period of the method

DP0, DP1, and DP2: calibration coefficients as shown in the following equation, where A is absorbance

$$\text{ppm} = \text{DP0} * \text{A}^2 + \text{DP1} * \text{A} + \text{DP2}.$$

Max: the maximum range of the method.

Form1: the default display form of the method, such as PO4 for a phosphate method.

Factor1: it is always 1 If the method has just one display form.

FormId: default is 0 and the user does not need to change it.

UnitId: default is 0 and the user does not need to change it.

DecNum: the number of decimal places in the displayed concentration

After a user defined method is created, click Write to Device to save the method.

6.3.3 Download Datalog

Click **Datalog** tap to open the datalog page. Click **Read Datalog List** to retrieve the datalog list from the SP-800 (Figure 21). Select a datalog entry from the list and then click **Read Datalog** to load the measurement values to uPyxis (Figure 22). The datalog can be saved as a CSV file.

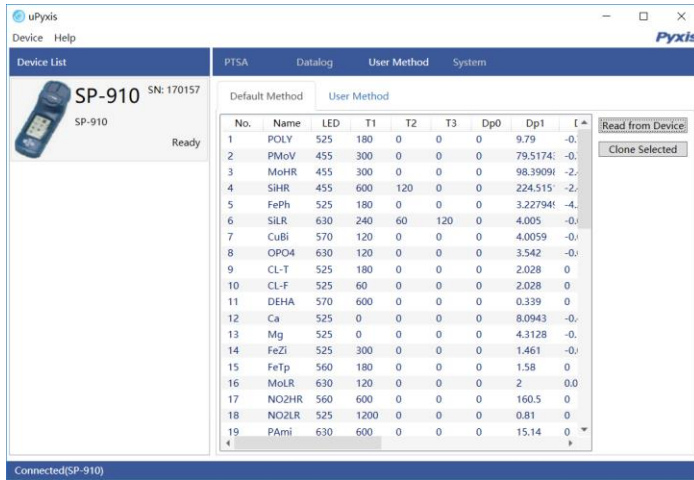

Figure 19 Load the default Methods

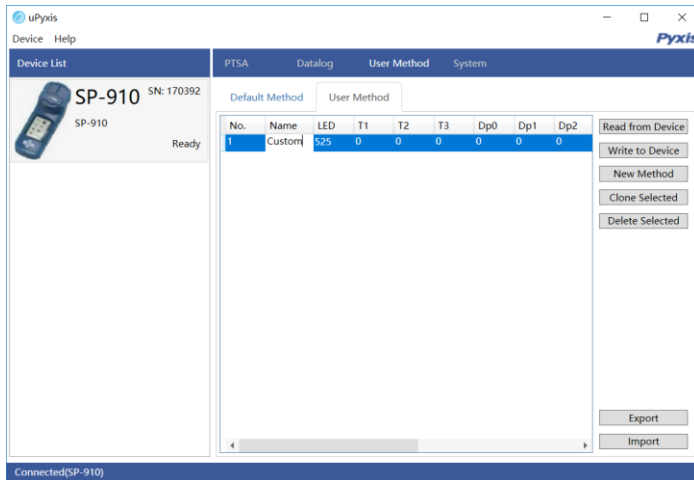

Figure 20 Add a User Defined Method

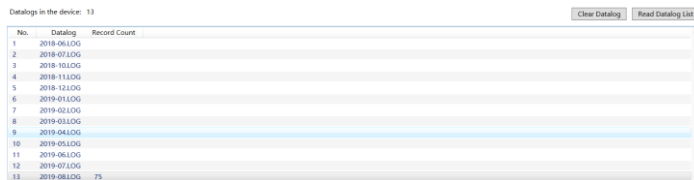

Figure 21 Datalog List

No.	Date/Time	Type	Value	Product Name	Product Factor	Method Name	Form	Voltage
1	8/2/2019 12:29:05 PM		0.00 ppm			CL-T	CL2	4.00 V
2	8/2/2019 2:11:50 PM		0.00 ppm			CL-T	CL2	3.81 V
3	8/2/2019 2:14:15 PM		0.00 ppm			CL-T	CL2	3.78 V
4	8/2/2019 2:23:28 PM		0.00 ppm			CL-T	CL2	3.72 V
5	8/2/2019 9:12:40 PM		0.00 ppm			CL-T	CL2	3.75 V
6	8/3/2019 11:23:22 AM		0.99 ppb	PTSA	1			4.11 V
7	8/3/2019 11:23:25 AM		1.08 ppb	PTSA	1			4.10 V
8	8/3/2019 11:24:32 AM		1.01 ppb	PTSA	1			4.07 V
9	8/3/2019 11:24:39 AM		0.93 ppb	PTSA	1			4.04 V
10	8/3/2019 11:24:43 AM		1.04 ppb	PTSA	1			4.02 V
11	8/3/2019 11:25:58 AM		1.05 ppb	PTSA	1			4.04 V
12	8/3/2019 11:26:06 AM		0.99 ppb	PTSA	1			4.00 V
13	8/3/2019 11:26:13 AM		1.05 ppb	PTSA	1			3.98 V
14	8/3/2019 11:30:42 AM		1.22 ppb	PTSA	1			4.05 V

Figure 22 Detailed Measurement Data

7 Maintenance

Use a soft cloth or lint free paper tissue to clean the sample vial compartment periodically. Remove debris, scale, and deposit promptly.

Although The SP-800 is protected from water damage, it is a good practice to avoid water entering the sample vial compartment and becoming trapping underneath the navigational control pad. Deposits left behind when the water is evaporated could affect Pyxis performance.

The SP-800 should be stored in the temperature range of 0 to 140°F (-18 to 60°C) and relative humidity less than 85% at 106 °F (41 °C). Do not leave the SP-800 in a parked vehicle. The temperature inside a parked vehicle can reach above 150 °F in summer and -20 °F in winter. Exposing the SP-800 to extreme temperature or humidity will cause a gradual decay in performance of fluorescence measurements and require more frequent calibrations.

During storage and transportation, do not leave a sample vial in the sample vial compartment. Close the lid of the sample vial compartment during storage and transportation.

Replace batteries when the SP-800 displays a warning message indicating LOW BATTERY voltage. Remove batteries from the SP-800 battery compartment if the SP-800 is going to be placed in storage for a long period time.

When the SP-800 is shipped, a desiccant pack is included in the desiccant compartment underneath the cover of the battery compartment. It is recommended that a new desiccant pack is replaced each time the batteries are replaced.

8 Troubleshooting

The SP-800 will prompt a warning message if it detects an abnormal condition or operation. On screen prompts direct the user to take appropriate corrective actions in most cases.

If an unspecific error occurs or the SP-800 cannot be turned on, reboot the instrument by taking a battery out of the battery holder and re-install the battery.

If the SP-800 has been idle for more than two months and cannot be turned on, replace all four batteries with four new AA alkaline batteries.

A diagnostics page can be launched by press the **SYS** icon in the main page. The software version and its associated hash code can be found in the diagnosis page. Contact Pyxis professionals at service@pyxis-lab.com and provide with following information to ensure high quality technical support.

Table 4 Contact Information

Items	Note
Contact Name	
Phone	
Email	
Customer Name	
Product Number (P/N)	Can be found on the product label on back of product
Serial Number (S/N)	Can be found on the product label on back of product
Firmware version	Can be found in diagnosis page
Problem Description	Capture warning message if applicable

9 Appendix A.

Pyxis Method and Hach® Method Number (PRMP) Cross Reference

Commented [LR5]: 同样道理该 Table 要修正参考前面 color 支持列表

Abbreviated Method Name	Method Name	Corresponding Hach © method	Hach Method Number
AL	Alumi	Aluminon Method for Aluminum	8012
ALKLR	Alkalinity	Alkalinity, Total, Low Range	N/A
ALKHR	Alkalinity	Alkalinity, Total, High Range	N/A
AZOL	Azole	Benzotriazole, UV Photolysis	8079
BLCH	Bleach	Direct method measuring sodium hypochlorite concentration	N/A
BLCHL	Bleach	Direct method measuring sodium hypochlorite concentration, Low Range	N/A
Br-T	Bromine	Bromine,DPD Method	8016
Ca	Ca	Calcium: Calmagite Colorimetric Method	8030
CaHR	Ca	Calcium hardness ,Murexide method	N/A
CaMgL	CaMg	Total hardness,Chlorophosphonazo colorimetric method , Ultra-Low Range	8374
CODLR	COD	Oxygen Demand, Chemical (Reactor Digestion 20 Minutes Method) ,Low range	10259
CODHR	COD	Oxygen Demand, Chemical (Reactor Digestion 20 Minutes Method) , High range	10259
CODUH	COD	Oxygen Demand, Chemical (Reactor Digestion 20 Minutes Method) ,Ultra-High Range	8000
CODUL	COD	Oxygen Demand, Chemical (Reactor Digestion 20 Minutes Method) ,Ultra-Low Range	8000
CLLR	CLLR	Turbidimetric method,Low Range	N/A
CLMR	CLMR	Turbidimetric method ,Medium Range	N/A
CL2HR	CL2High	High Range DPD Chlorine	10070
CL2UH	CL2UH	Free Chlorine, Iodimetr method ,Ultra-High Range	N/A
CL-F	F-Chlorine	Chlorine, Free, DPD	8021
CLTMB	Chlorine, Free	Free chlorine ,TMB method	N/A
CIO2	CIO2-DPD	Chlorine Dioxide, DPD	10126
CIO2D	CIO2Direct	Chlorine Dioxide, Direct Reading	8345
CLO2H	CIO2Direct	Chlorine Dioxide, Direct Reading,High Range	N/A
CL-T	T-Chlorine	Chlorine, Total, DPD	8167
CN	Cyanide	Pyridine-Pyrazalone Method for Cyanide	8027
COLOR	Color	Color, APHA Platinum-Cobalt Standard Method	8025
Cr6	Cr6	Hexavalent chromium, 1,5-Diphenylcarbohydraide Method	8023
CrT	CrTot	Chromium total Alkaline Hypobromite Oxidation Method,	8024

Abbreviated Method Name	Method Name	Corresponding Hach © method	Hach Method Number
CuBi	Cu_Bicinch	Copper, Bicinchoninate	8506
CuLR	CuPorp	Copper, Porphyrin method	8143
CYAN	CYAN	Turbidimetric method for cyanuric acid	8139
CYN-F	Cyclohexylamine	Cyclohexylamine, Fluorescent method	N/A
DEHA	DEHA	DEHA, Iron Reduction Method for Oxygen Scavengers	8140
DO	DO	Dissolved Oxygen, Iodimetry method	N/A
F	Floride	SPADNS 2 Method for Fluoride	8029
FeMo	FeMo	Iron, for cooling water with molybdenum-based treatment	8365
FePh	Fe_phenanth	Iron, 1,10 phenanthroline	8008
FeSal	Fe-Sal	Total Iron using 5-Sulfosalicylic Acid Dihydrate	N/A
FeTp	FeTptz	Iron, TPTZ	8112
FeZi	FeZine	Iron, FerroZine	8147
H2O2	H2O2	Hydrogen peroxide, Iodimetry method	N/A
H2O2L	H2O2L	Hydrogen peroxide, DPD method, Low Range	N/A
Mg	Mg	Calcium: Calmagite Colorimetric Method	8030
MnHR	MnHigh	High Range Manganese, Periodate Oxidation Method	8034
MnLR	MnLow	Low Range Manganese PAN Method	8149
MoHR	Mo_HighRange	Molybdenum, High Range, Mercaptoacetic Acid	8036
MoLR	Mo_LowRange	Molybdenum, Low Range, Ternary Complex	8169
N2H4	N2H4	P-Dimethylaminobenzaldehyde Method for Hydrazine	8141
NH2C	NH2CL	Indophenol Method for MonoChloramine	10171
N-TLR	N-TLR	Nitrogen, Total (Test 'N Tube Method) ,LR TNT Persulfate Digestion Method	10071
N-THR	N-TLR	Nitrogen, Total (Test 'N Tube Method) ,HR TNT Persulfate Digestion Method	10072
NH3S	NH3Sal	Ammonia Salicylate Method	8155
NH3-F	NH3-F	Ammonia Nitrogen ,Fluorescent Method	N/A
NH3LR	NH3LR	Nitrogen, Ammonia (Test 'N Tube) - Low range, Salicylate Method	10023
NH3HR	NH3HR	Nitrogen, Ammonia (Test 'N Tube) -High range, Salicylate Method	10031
Ni	Ni	PAN method for nickel	8150
NO2D	NO2D	Direct method for nitrite	N/A
NO2H	NO2H	Nitrite, High Range, Ferrous Sulfate	8153
NO2L	NO2L	Nitrite, Low Range, Diazotization	8507
NO3HR	NO3H	High range nitrate	8039
NO3MR	NO3M	Middle range nitrate	8171

Abbreviated Method Name	Method Name	Corresponding Hach © method	Hach Method Number
NO3CA	NO3CA	NITRATE, High Range, Test 'N Tube Chromotropic Acid Method	10020
O3	O3	Ozone ,DPD method	N/A
PAA	PAA	Peroxyacetic , Iodimetry method	N/A
OPO4	OPO4	Phosphorus, Reactive, Orthophosphate Ascorbic Acid	8048
OrgP	Phosphonate	Phosphonates, Persulfate UV Oxidation	8007
PAmi	OPO4-Amino	Phosphorus, Reactive, Amino Acid	8178
P-TLR	P-TLR	Phosphorus, Total (Test 'N Tube Method) -LR PhosVer 3 with Acid Persulfate Digestion	8190
P-THR	P-THR	Phosphorus, Total (Test 'N Tube Method) -HR-Molybdovanadate Method with Acid Persulfate Digestion	10127
pH	pH	Phenol red method for pH	10076
PMoV	OPO4-MoV	Phosphorus, Reactive, Molybdovanadate	8114
POLY	Polymer	Turbidimetric method for anionic polymers	N/A
Sb3+	Sb3+	Antimony Trivalent ,PADAP Method	N/A
Sb-T	Sb-T	Antimony, Total ,PADAP Method	N/A
S2-	Sulfide	Methylene Blue Method for Sulfide	8131
SiHR	SiHR	Silica, High Range, Silicomolybdate	8185
SiLR	SiLR	Silica, Low Range, Heteropoly Blue	8186
SO3LR	SO3LR	Sulfite,OPA method ,Low Range	N/A
SO3HR	SO3HR	Sulfite,OPA method , High Range	N/A
SO4	SO4	Sulfate	8051
TOC	TOC	Total Organic Carbon	10129
Urea	Urea	Urea (Reactor Digestion Method)	N/A
ZnXO	ZnXO	Zinc ,Xylenol orange method	N/A
Zn	Zinc	Zincon Method for Zinc	8009

Hach © is a registered trademark of the Hach Company, Loveland, CO USA