

Pyxis®

HM-900 Oil-In-Water Analyzer

User Manual



Water Professionals Deserve Better Tools.

www.pyxis-lab.com

HM-900 Oil-in-Water Analyzer User Manual

July 28, 2020

Rev. 1.04

Pyxis Lab, Inc.

1729 Majestic Dr. Suite 5

Lafayette, CO 80026 USA

www.pyxis-lab.com

Table of Contents

1	Introduction	2
1.1	Main Features	3
2	Specifications	3
3	Unpacking Instrument	3
3.1	Standard Accessories	4
3.2	Optional Accessories	4
4	Installation	5
4.1	Battery Installation	5
5	Instrument Overview	6
5.1	Sample Vial Compartment	6
5.2	Light Shield Cover	6
5.3	Navigational Control Pad	6
5.4	HM-900 On/Off	7
5.5	Power Settings	7
5.6	Main Screen	7
6	Measurement	7
6.1	24 mm Vial Extraction Procedure	8
6.2	16 mm Vial Extraction Procedure	9
6.3	Dissolved or Dispersed Oil Measurement.....	10
7	Calibration	11
7.1	User-Defined Calibration Curves.....	11
7.2	Calibration Using a Secondary Standard.....	12
8	Device Maintenance and Precaution	13
8.1	Best Practices	13
9	Troubleshooting	13
9.1	Over Range Warning	13
9.2	User-Defined Calibration Curve Considerations.....	14
10	Contact Us	14

Warranty Information

Confidentiality

The information contained in this manual may be confidential and proprietary and is the property of Pyxis Lab, Inc. Information disclosed herein shall not be used to manufacture, construct, or otherwise reproduce the goods described. Information disclosed herein shall not be disclosed to others or made public in any manner without the express written consent of Pyxis Lab, Inc.

Standard Limited Warranty

Pyxis Lab warrants its products for defects in materials and workmanship. Pyxis Lab will, at its option, repair or replace instrument components that prove to be defective with new or remanufactured components (i.e., equivalent to new). The warranty set forth is exclusive and no other warranty, whether written or oral, is expressed or implied.

Warranty Term

The Pyxis warranty term is thirteen (13) months ex-works. In no event shall the standard limited warranty coverage extend beyond thirteen (13) months from original shipment date.

Warranty Service

Damaged or dysfunctional instruments may be returned to Pyxis for repair or replacement. In some instances, replacement instruments may be available for short duration loan or lease.

Pyxis warrants that any labor services provided shall conform to the reasonable standards of technical competency and performance effective at the time of delivery. All service interventions are to be reviewed and authorized as correct and complete at the completion of the service by a customer representative, or designate. Pyxis warrants these services for 30 days after the authorization and will correct any qualifying deficiency in labor provided that the labor service deficiency is exactly related to the originating event. No other remedy, other than the provision of labor services, may be applicable.

Repair components (parts and materials), but not consumables, provided during a repair, or purchased individually, are warranted for 90 days ex-works for materials and workmanship. In no event will the incorporation of a warranted repair component into an instrument extend the whole instrument's warranty beyond its original term.

Warranty Shipping

A Repair Authorization (RA) Number must be obtained from Pyxis Technical Support before any product can be returned to the factory. Pyxis will pay freight charges to ship replacement or repaired products to the customer. The customer shall pay freight charges for returning products to Pyxis. Any product returned to the factory without an RA number will be returned to the customer. To receive an RMA you can generate a request on our website at <https://pyxis-lab.com/request-tech-support/>.

Pyxis Technical Support

Contact Pyxis Technical Support at +1 (866) 203-8397, service@pyxis-lab.com, or by filling out a request for support at <https://pyxis-lab.com/request-tech-support/>.

1 Introduction

The Pyxis HM-900 is a handheld portable fluorometer that measures the oil-in-water concentration in a sample. Oil is a complex mixture of organic compounds. The term “oil” can be referred to as a range of different classes of chemical compounds, such as vegetable oil and petroleum oil. Almost all oil substances fluoresce under UV or near UV excitation in a different degree because invariably, all oil contains aromatic or other fluorescent compounds.

Two Extraction Methods: The HM-900 offers measurement of oil content through extraction to hexane and other organic solvents as preferred by the user. The fluorescence intensity of the solvent sample containing oil is then analyzed by the HM-900. The HM-900 offers two extraction methods that can be utilized as outlined in this manual:

- 24 mm Vial Extraction Method: Enables the user to self-prepare their own hexane extracted sample for measurement.
- 16 mm Vial Extraction Method: Enables the user to utilize the Pyxis 16 mm, prepared, non-flammable solvent vial and adapter for a safer and more convenient measurement reducing sample preparation steps.

Built-In Default Curves: The HM-900 has three default built-in calibration curves for Marine Crude Oil, #1 Diesel/Kerosene, and Heavy Fuel Oil. The user may select which of these three formats are desired for final measurement display. Users may also create up to 7 customized/user-defined calibration curves for the specific oil desired.

Common Alternative Methods: Oil-in-water analysis by fluorescence is a widely used field-testing method but is fundamentally different from other methods. Commonly used alternative methods include the following:

- EPA 1664 gravimetric method measures the amount of oil extracted to a solvent by weight.
- The Infrared method (ASTD D7678) measures the absorption of oil extracted to cyclohexane in the range of 1370–1380 cm^{-1} by methyl group in the oil, using an IR spectrophotometer to quantify the oil concentration.

User-Defined Calibration Curves: Due to the HM-900 portable fluorometer utilizing the fluorescent signature of the oil in water, the concentrations measured by the HM-900 versus other methods for a given water sample may agree with each other in a relative sense, but this is not always a guarantee. As such, the HM-900 enables users to create their own user-defined calibration curves based on the specific organic solvent and vial size desired. This manual covers the procedures for integrating a user-defined calibration curve for future calibration.

Secondary Standard for Rapid Calibration: Preparation of a true oil in water calibration standard is both time consuming and subject to error. As such, the HM-900 can also be calibrated using two Pyxis synthetic oil-in-water secondary standards (OIW-100LR and OIW-1000HR). This approach enables users to utilize a synthetic oil in water standard for rapid device calibration, improved accuracy, and extended storage/shelf life of the calibration solution.

Direct Read Method For Dissolved or Emulsified Oil: The HM-900 can be used to directly analyze oil in water content without the need for extraction using UV fluorescence methodology. This method is commonly utilized for samples containing dissolved or lightly emulsified oil.

1.1 Main Features

- Pre-programmed calibration curves for primary oil classes:
 - Marine Crude Oil
 - #1 Diesel-Kerosene
 - Heavy Fuel Oil
- Dual-channel wavelengths of fluorescence enable automatic range selection
- Both 24 mm and 16 mm sample vials may be used with HM-900
- Easy-to-follow calibration steps displayed on the screen
- Suitable for solvent extraction methods
- Suitable for direct read dissolved/emulsified oil methods

2 Specifications

Table 1. HM-900 Specifications

Item	Specifications*
Part Number (P/N)	52201
Range	0.1–1000, auto channel switch
Accuracy	0.1 ppm
Method	UV-Fluorescence
Excitation/Emission Wavelengths	365/410nm and 470/600+nm
Display	7.6×5.0 inch (192×128 mm) LCD, readable under direct sunlight
Power Supply	4 AA alkaline batteries
Typical Battery Life	2 months
Dimension (L×W×H)	10.4×3.5×2.4 inch (265×88×62 mm)
Weight	1.1 lbs (510 g)
Operational Temperature	14–122 °F (-10–50 °C)
Storage Temperature	-4–158 °F (-20–70 °C)
Enclosure Rating	IP65
Regulation	CE

* With Pyxis's continuous improvement policy, these specifications are subject to change without notice.

3 Unpacking Instrument

Remove the instrument and accessories from the shipping container and inspect each item for any damage that may have occurred during shipment. Verify that all items listed on the packing slip are included. If any items are missing or damaged, please contact Pyxis Customer Service at service@pyxis-lab.com.

3.1 Standard Accessories

- Four (4) AA alkaline batteries
- Two (2) 10 mL Sample Vials, 24 mm diameter P/N: MA-24
- 16 mm Vial Oil-In-Water Adapter P/N: 52213
- Bluetooth/USB Adapter for Desktop P/N: MA-NEB
- User Manual available online at www.pyxis-lab.com/support.html

3.2 Optional Accessories

The following optional accessories can be ordered from Pyxis Customer Service (order@pyxis-lab.com) or Pyxis eStore at <https://pyxis-lab.com/shop/>.



Figure 1. 16 mm Solvent Filled Extraction Vial



Figure 2. Oil-in-Water High Secondary Standard (OIW-1000 HR)

Table 2. HM-900 Optional Accessories Specifications

Specification	16 mm Solvent Filled Extraction Vial	Oil-in-Water Low Secondary Standard	Oil-in-Water High Secondary Standard
Product	16mm-OIW	OIW-100 LR	OIW-1000 HR
Part Number (P/N)	52211	21036	21057
Range*	0–1000 ppm	100 ppm as Marine-Offshore Oil	1000 ppm as Marine-Offshore Oil
Container	16 mm Extraction Vial pre-filled with non-flammable solvent	16 oz/500 mL Nalgene Amber Narrow Mouth Sample Bottle	16 oz/500 mL Nalgene Amber Narrow Mouth Sample Bottle
Shelf Life		6 months	
Net Volume	12 vials, 5 mL each	510±10 mL	510±10 mL
Net Weight	12 vials, 5 mL each	510±10 g	510±10 g

* With undiluted solutions

4 Installation

4.1 Battery Installation

The HM-900 is powered by four AA-size alkaline batteries. A set of batteries typically lasts for three months. When the battery capacity is low, the HM-900 will prompt a "LOW BATTERY" warning. Replace all four batteries to resume operation of the HM-900 after the battery warning.

NOTE Do not use rechargeable nickel cadmium (NiCad) batteries or any AA-size lithium batteries.

The HM-900 battery compartment, shown in Figure 3, is on the back side of the instrument. Insert a small pad underneath the screen area to make the back-surface level when the instrument is turned upside down. Install batteries using the following steps:

1. Remove the battery compartment cover by loosening four screws.
2. Insert four batteries into the battery holder (Figure 3). Make sure the positive battery polarity marker (+) is aligned with the positive marker (+) on the battery holder.
3. Replace the battery compartment cover, making sure that the sealing O-ring is lying flat on the battery holder and tighten the four screws.

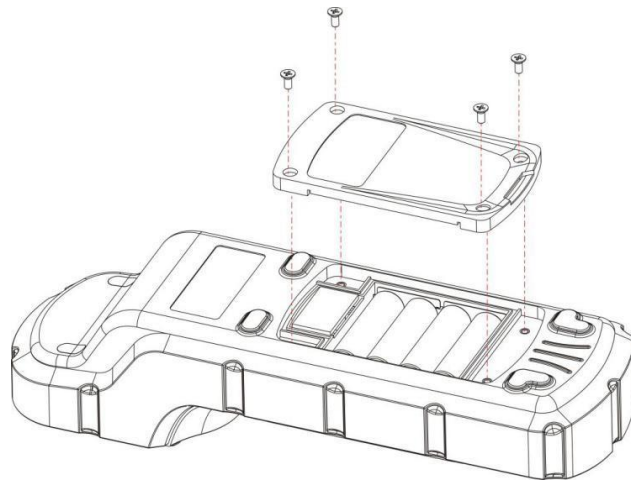

Figure 3. HM-900 battery compartment

5 Instrument Overview

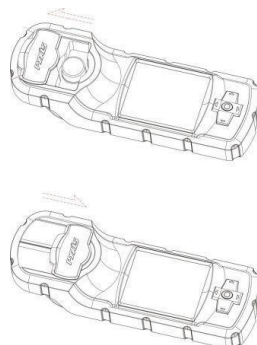

Figure 4.

5.1 Sample Vial Compartment

The sample vial compartment is shown in Figure 4, along with a 10 mL sample vial. When the sample vial is inserted into the sample vial compartment, the triangular mark on the sample vial should be aligned with the 6 o'clock position of the sample vial compartment. However, aligning the triangular mark on the sample vial to any position of the sample vial compartment is acceptable as long as the position is consistent.

The sample vial compartment should be kept clean. A small amount of foreign material could significantly affect turbidity and fluorescence measurement results. Use a soft cloth or lint free paper tissue to clean sample vial compartment periodically. Remove debris, scale, and deposit promptly.

5.2 Light Shield Cover

The light shield cover is shown in Figure 4. The light shield cover can be conveniently slid between open and closed positions. The light shield cover is held firmly in these positions by permanent magnets.

The light shield cover should be in the closed position during storage, transportation, and measuring, especially while performing fluorescence measurements. When powered on, the HM-900 performs a self-diagnosis including a check of the performance of the optical devices. The light shield door should always be in the closed position to shield interference from ambient light during self-diagnosis. Care should be taken to avoid water or debris being trapped in the track of the light shield door.⁷

WARNING

Magnetic sensitive devices, including but not limited to, credit cards, watches, and hard disks, should be kept at a distance of at least 2 inches from the light shield cover to avoid possible damage and/or loss of stored data.

5.3 Navigational Control Pad

The HM-900 navigational control pad consists of five keys as shown in Figure 4. The left, right, up, and down keys are navigational keys that are used to select an icon, a button, or other items in various pages. The center key is the **OK** key. Press the **OK** key on a selected item to launch the action associated with the selected item. The **OK** key is also used to accept the current selection, like the ENTER key on a computer keyboard.

5.4 HM-900 On/Off

To power on the HM-900, hold the **OK** key, and release when the LCD is lit.

To power off the HM-900, navigate to the **Power** icon () and press the **OK** key. Alternatively, hold the **OK** key for 5 seconds in any menu.

5.5 Power Settings

5.5.1 Auto Power Off

To conserve battery life, the HM-900 automatically turns itself off with no key activity for a given period, except during a measurement.

5.5.2 Auto LCD Power Saving

The HM-900 automatically turns LCD backlight off with no key activity. Pressing any key will turn on the LCD backlight. Under normal ambient lighting conditions, icons and other contents shown on the LCD screen are readable without the backlight being on.

5.6 Main Screen

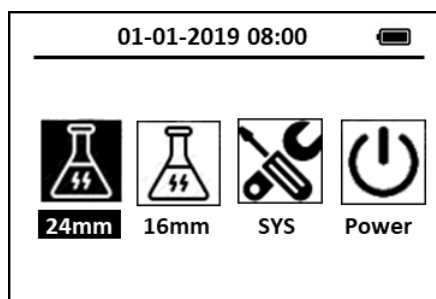

Figure 5. HM-900 Main screen

Once the HM-900 is powered, the **Main** screen will be displayed (Figure 5). The HM-900 provides intuitive icon-driven user operations. On the **Main** screen, four major features are illustrated. A brief description of each feature is given in Table 3 below. Detailed operation instructions can be found in the following chapters.

Table 3. HM-900 Main Screen Features

Title	Description
24 mm	24 mm Vial Extraction
16 mm	16 mm Vial Extraction
SYS	Diagnosis Information
Power	HM-900 On/Off

6 Measurement

The HM-900 has three default, built-in calibration curves for Marine Crude Oil, Kerosene (#1 Diesel), and Heavy Fuel Oil. The user can measure the raw fluorescence signal for a sample with a known oil-in-water concentration and create up to 6 user-defined methods.

6.1 24 mm Vial Extraction Procedure

1. Pour 10 mL of hexane solvent into a 10 mL sample vial to be used as the solvent blank.
2. Place the solvent blank vial into the HM-900 sample compartment.
3. With the **24 mm** icon highlighted, press the **OK** key.
4. Select an oil type (i.e. a calibration curve) desired for this test.
5. Once an oil type is selected, use the left or right key to select the test range of the selected oil type. **LR** indicates the low-range test, **HR** indicates the high-range test.
6. With **ZERO** highlighted, press the **OK** key to measure the solvent blank.
7. Prepare the hexane extraction sample:
 - (a) Based on the estimated sample oil concentration, use Table 4 below to determine the recommended sample volume, hexane volume, and multiplication factor.
 - (b) Adjust the sample pH down to between 1 and 2 using diluted sulfuric acid or hydrochloric acid.
 - (c) Pour the recommended sample volume of the pH-adjusted sample into a glass separatory funnel.
 - (d) Using a pipette, add the recommended hexane volume to the separatory funnel.
 - (e) Shake the separatory funnel for two minutes (Figure 6).
 - (f) Allow the upper hexane layer in the separatory funnel to float and separate from the bottom aqueous layer for a period of one minute.
 - (g) Pour the separated upper hexane layer from the separatory funnel into a second 10 mL sample vial. This will be your hexane extraction sample to be tested.
8. Place the 10 mL sample vial containing the hexane extraction sample into the HM-900 sample compartment.
9. With **READ** highlighted, press the **OK** key.
10. The oil-in-water concentration in hexane extraction will be displayed as seen in Figure 7.
11. Multiply the final reading by the multiplication factor.
12. The calculated value is the oil concentration in the sample.

Table 4. 24 mm Vial Volume Recommendations and Measurement Conversion Table

Estimated Sample Oil Concentration (ppm)	Recommended Sample Volume (mL)	Recommended Hexane Volume (mL)	Multiplication Factor
0–10	1000	10	0.01
10–100	100	10	0.1
100–1000	100	100	1

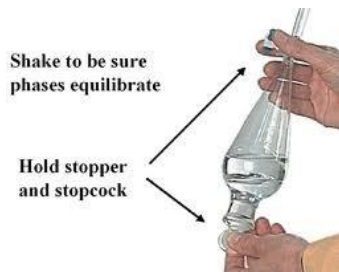

Figure 6.

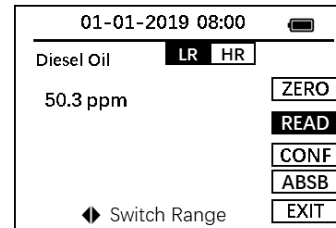

Figure 7.

6.2 16 mm Vial Extraction Procedure

For easier more efficient testing, this method requires the 16 mm vial/test tube adapter (P/N: 52213) and Pyxis 16 mm prepared extraction vials (P/N: 52211) with pre-filled extraction solvent as shown in Figure 8. The solvent used in this method is 3M ethoxy-nonafluorobutane. It is a non-flammable, low toxicity solvent.

1. Insert the 16 mm vial adapter into the sample compartment, make sure the text on the adapter is right-side-up (Figure 9).
2. Prepare the extraction solvent blank:
 - (a) Using a pipette add 3 or 6 mL of deionized (DI) water to a Pyxis 16 mm extraction vial with pre-filled extraction solvent.

NOTE Users may choose 3 or 6 mL of sample depending on the projected concentration of oil. (e.g. for higher concentration samples use 3 mL.)
 - (b) Shake the vial for two minutes.
 - (c) Let the vial settle for one minute. This will be your solvent blank vial.
3. Place the extraction solvent blank vial into the 16 mm vial adapter.
4. With the **16 mm** icon highlighted, press the **OK** key to launch the method.
5. Select an oil type (i.e. a calibration curve) desired for this test.
6. Once an oil type is selected, use the left or right key to select the test range of the selected oil type. **LR** indicates the low-range test, **HR** indicates the high-range test.
7. With **ZERO** highlighted, press the **OK** key to measure the solvent blank.
8. Prepare the sample:
 - (a) Using a pipette add 3 or 6 mL (whichever was used for the solvent blank) of sample to be tested to another Pyxis 16 mm extraction vial with pre-filled extraction solvent.
 - (b) Shake the vial for 2 minutes.
 - (c) Let the vial settle for one minute. This will be your prepared sample vial for final measurement.
9. Place the sample vial into the 16 mm vial adapter.
10. With **READ** highlighted, press the **OK** key to measure the oil concentration in the extraction solvent.
11. Multiply the displayed value according to the sample volume listed in Table 5 below to calculate the final oil concentration in the sample.

Table 5. 16 mm Vial Measurement Conversion Table

Sample Volume (mL)	Multiplication Factor
3	2
6	1

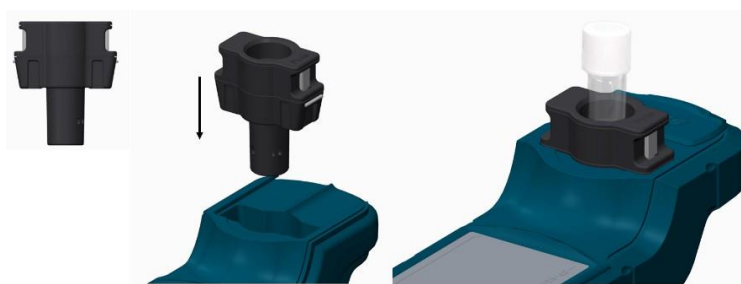
**Figure 8.** 16 mm extraction vial pre-filled with solvent (P/N: 52211)
16 mm Vial Adapter (P/N: 52213)**Figure 9.**

6.3 Dissolved or Dispersed Oil Measurement

Water samples containing dissolved oil or lightly dispersed/emulsified oil can be measured directly without extracting oil to hexane or other organic solvents. A user-defined calibration curve for the dissolved oil measurement can be created with the procedure described in the **User-Defined Calibration Curves** section. Calibration standards can be prepared by emulsifying a given amount of oil into deionized water. Alternatively, the oil concentration of a real water sample can be first analyzed by the extraction procedure and the sample can be directly used as a calibration standard to calibrate the direct non-extraction procedure.

Some non-homogenous water samples may need to be emulsified with an addition of surfactants.

7 Calibration

7.1 User-Defined Calibration Curves

When creating a user-defined calibration curve, please use hexane or other organic solvents that are not contaminated by oil. Please prepare a series of calibration solutions (a minimum of two calibration solutions are required to include the solvent blank). Use the solvent and the target oil type desired.

1. With either the **24 mm** or **16 mm** icon highlighted, press the **OK** key.
2. Select a user-defined method among 7 templates (named USR-1–USR-7).
3. Use the left or right key to select the calibration range of the selected user method. **LR** indicates the low calibration range, **HR** indicates the high calibration range.
4. With **CONF** highlighted, press the **OK** key (Figure 10).
5. Place the solvent blank vial into the sample compartment.
6. With **CALC** highlighted, press the **OK** key to measure and accept the solvent blank.
7. Place the calibration solution into the sample compartment.
8. With **CALC** highlighted, press the **OK** key (Figure 11).
9. Input the standard oil concentration using the four keys around the central **OK** key (Figure 12).
10. With **SAVE** highlighted, press the **OK** key to save the first calibration range (Figure 13).
11. After a calibration range is successfully saved, choose one of two options:
 - (a) Repeat steps 3–10 with a second calibration solution to calibrate the other curve under the selected method or
 - (b) With **EXIT** highlighted, press the **OK** key to exit the measurement interface (Figure 14).

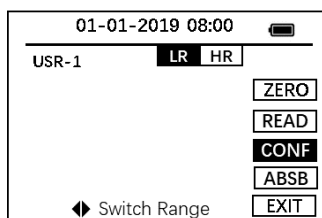

Figure 10.

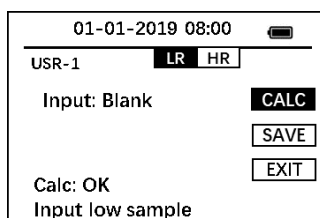

Figure 11.

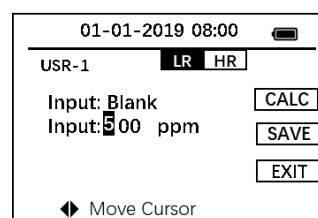

Figure 12.

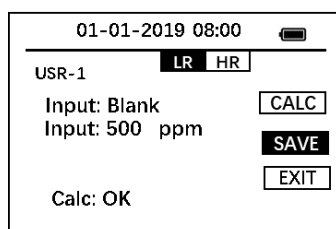

Figure 13.

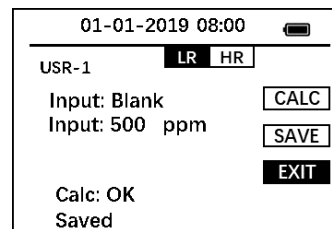

Figure 14.

7.2 Calibration Using a Secondary Standard

Technically, a universal oil-in-water standard does not exist. The user can either use the three built-in, pre-calibrated methods to measure a sample. Or, the user can create a user-defined calibration curve pertaining to a specific sample type as described in the **User-Defined Calibration Curves** section. Or, to avoid the need to prepare an oil-in-water standard, the user can conveniently use a synthetic secondary standard to calibrate the user defined methods.

The equivalent concentration value corresponding to each user-defined method must be determined after the user-defined method is created and recorded for later use. The equivalent concentrations of the Pyxis OIW-100LR and OIW-1000HR secondary standards for the three built-in oil types (pre-calibrated methods) are listed below.

Table 6. Secondary Standard Equivalent ppm Using Pre-Calibrated HM-900 Methods

Pre-Calibrated Oil Type	OIW-100LR Secondary Standard Equivalent ppm Value/Low Range	OIW-1000HR Secondary Standard Equivalent ppm Value/High Range
Marine-Offshore Oil	100	1000
#1 Diesel/Kerosene	400	4000
Heavy Oil	20	200

7.2.1 Determine the Secondary Standard Equivalent Concentration For a User-Defined Calibration Curve

1. Define a user-defined calibration curve using the steps from the **User-Defined Calibration Curves** section.
2. Take a measurement using either the OIW-100LR or OIW-1000HR Secondary Standard as the sample and the user-defined calibration curve as the method. See either the **24 mm Vial Extraction Procedure** or **16 mm Vial Extraction Procedure** sections for detailed steps.

NOTE *Skip the extraction portion of these procedures and insert the OIW standard directly into the vial and read value. The OIW standard is not an oil, it is synthetic, and as such does not require extraction.*

3. Record the measured concentration and the associated user-defined calibration curve name on the secondary standard bottle for future calibrations.

7.2.2 Calibrate a User-Defined Calibration Curve with a Secondary Standard

1. Take a measurement using either the OIW-100LR or OIW-1000HR Secondary Standard as the sample and the user-defined calibration curve as the method. See either the **24 mm Vial Extraction Procedure** or **16 mm Vial Extraction Procedure** sections for detailed steps.

NOTE Skip the extraction portion of these procedures and insert the OIW standard directly into the vial and read value. The OIW standard is not an oil, it is synthetic, and as such does not require extraction.

2. Just after the reading, with **CONF** highlighted, press the **OK** key.
3. With **CALC** highlighted, press the **OK** key to start the calibration.
4. Input the equivalent concentration using the four keys around the central **OK** key. See the **Determine the Secondary Standard Equivalent Concentration For a User-Defined Calibration Curve** for details on how to determine the equivalent concentration.
5. With **SAVE** highlighted, press the **OK** key to save the calibration.

8 Device Maintenance and Precaution

8.1 Best Practices

- Use a glass container to transfer oil-in-water samples.
- Avoid bulk surface oil when taking a sample.
- Analyze the sample within 3 hours after taking it.
- Take at least 1000 mL sample to be representative.
- For 24 mm vial extraction, make sure the separatory flask is well-sealed to prevent hexane solvent evaporation during the extraction process.

9 Troubleshooting

9.1 Over Range Warning

If the oil concentration is too high and over the range of the selected calibration curve, a warning message will be displayed (Figure 15). Dilute the sample or use a different sample-to-solvent ratio listed in Table 4 for 24 mm vials and Table 5 for 16 mm vials in the extraction process.

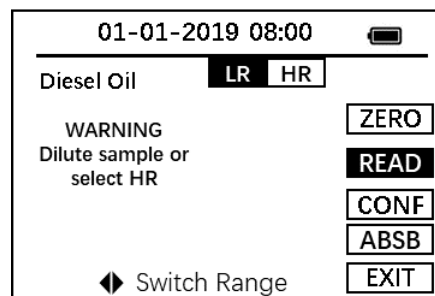

Figure 15.

9.2 User-Defined Calibration Curve Considerations

9.2.1 Contaminated Extraction Solvent

Make sure the extraction solvent is not contaminated. You can do this by using a pre-programmed default calibration curve to measure the solvent directly as though it is an extraction test. The results will determine if the solvent is contaminated with oil. If a significant oil concentration is measured, the solvent is likely being contaminated and should not be used for development of user-defined calibration curves.

9.2.2 Oil Concentration Too High For Measurement

If the oil concentration in a user developed standard is too high, a warning message will be displayed. Please add more solvent to dilute the calibration standard to appropriate range of detection of the HM-900.

10 Contact Us

Pyxis Lab, Inc

1729 Majestic Dr. Suite 5
Lafayette, CO 80026 USA

www.pyxis-lab.com

Phone: +1 (866) 203-8397

Email: service@pyxis-lab.com